

TEST REPORT

Application No.: GZEM2009015348HS
Applicant: ETS Products Philippines Inc.
Address of Applicant: Berthaphil 4 Warehouse 2C, Civil Aviation Complex Clark, Clark Freeport, Pampanga 2023, Philippines
Manufacturer: The same as applicant
Address of Manufacturer: The same as applicant
Factory: The same as applicant
Address of Factory: The same as applicant
Equipment Under Test (EUT):
EUT Name: Air purifier
Model No.: AP-90
Trade Mark: ETS Products
Standard(s): EN 55014-1:2017
 EN IEC 61000-3-2:2019
 EN 61000-3-3:2013+A1:2019
 EN 55014-2:2015
Date of Receipt: 2020-09-25
Date of Test: 2020-09-28 to 2020-10-13
Date of Issue: 2020-10-28

Test Result:	Pass*
---------------------	--------------

* In the configuration tested, the EUT complied with the standards specified above.

The CE mark as shown below can be used, under the responsibility of the manufacturer, after completion of an EU Declaration of Conformity and compliance with all relevant EU Directives.



Kobe Jian
EMC Laboratory Manager



Unless otherwise agreed in writing, this document is issued by the Company subject to its General Conditions of Service printed overleaf, available on request or accessible at <http://www.sgs.com/en/Terms-and-Conditions.aspx> and, for electronic format documents, subject to Terms and Conditions for Electronic Documents at <http://www.sgs.com/en/Terms-and-Conditions/Terms-e-Documents.aspx>. Attention is drawn to the limitation of liability, indemnification and jurisdiction issues defined therein. Any holder of this document is advised that information contained hereon reflects the Company's findings at the time of its intervention only and within the limits of Client's instructions, if any. The Company's sole responsibility is to its Client and this document does not exonerate parties to a transaction from exercising all their rights and obligations under the transaction documents. This document cannot be reproduced except in full, without prior written approval of the Company. Any unauthorized alteration, forgery or falsification of the content or appearance of this document is unlawful and offenders may be prosecuted to the fullest extent of the law. Unless otherwise stated the results shown in this test report refer only to the sample(s) tested and such sample(s) are retained for 30 days only.
Attention: To check the authenticity of testing /inspection report & certificate, please contact us at telephone: (86-755) 8307 1443, or email: CN.Doccheck@sgs.com

Revision Record				
Version	Chapter	Date	Modifier	Remark
01		2020-10-28		Original

Authorized for issue by:			
Tested By	<i>Michael Huang</i>		2020-09-28 to 2020-10-13
	Michael_Huang /Project Engineer		Date
Checked By	<i>Terry Lai</i>		2020-10-28
	Terry_Lai /Reviewer		Date



Unless otherwise agreed in writing, this document is issued by the Company subject to its General Conditions of Service printed overleaf, available on request or accessible at <http://www.sgs.com/en/Terms-and-Conditions.aspx> and, for electronic format documents, subject to Terms and Conditions for Electronic Documents at <http://www.sgs.com/en/Terms-and-Conditions/Terms-e-Documents.aspx>. Attention is drawn to the limitation of liability, indemnification and jurisdiction issues defined therein. Any holder of this document is advised that information contained hereon reflects the Company's findings at the time of its intervention only and within the limits of Client's instructions, if any. The Company's sole responsibility is to its Client and this document does not exonerate parties to a transaction from exercising all their rights and obligations under the transaction documents. This document cannot be reproduced except in full, without prior written approval of the Company. Any unauthorized alteration, forgery or falsification of the content or appearance of this document is unlawful and offenders may be prosecuted to the fullest extent of the law. Unless otherwise stated the results shown in this test report refer only to the sample(s) tested and such sample(s) are retained for 30 days only.

Attention: To check the authenticity of testing /inspection report & certificate, please contact us at telephone: (86-755) 8307 1443, or email: CN.Doccheck@sgs.com

2 Test Summary

Emission Part				
Item	Standard	Method	Requirement	Result
Conducted Emissions at Mains Terminals (150kHz-30MHz)	EN 55014-1:2017	CISPR 16-2-1	N/A	Pass
Radiated Emissions (30MHz-1GHz)	EN 55014-1:2017	CISPR 16-2-3	N/A	Pass
Harmonic Current Emission	EN IEC 61000-3-2:2019	EN IEC 61000-3-2:2019	Class A	Pass
Voltage Fluctuations and Flicker	EN 61000-3-3:2013 +A1:2019	EN 61000-3-3:2013 +A1:2019	Clause 5 of EN 61000-3-3	Pass

N/A: Not applicable

Immunity Part				
Item	Standard	Method	Requirement	Result
Electrostatic Discharge	EN 55014-2:2015	EN 61000-4-2:2009	4kV Contact Discharge 8kV Air Discharge	Pass
Radiated Immunity (80MHz-1GHz)	EN 55014-2:2015	EN 61000-4-3:2006 +A1:2008+A2:2010	3V/m, 80%, 1kHz Amp. Mod.	Pass
Electrical Fast Transients/Burst at Power Port	EN 55014-2:2015	EN 61000-4-4:2012	1kV 5/50ns Tr/Td 5kHz Repetition Frequency	Pass
Surge at Power Port	EN 55014-2:2015	EN 61000-4-5:2014	1.2/50µs Tr/Td 1kV Line to Line 2kV Line to Ground	Pass
Voltage Dips and Interruptions	EN 55014-2:2015	EN 61000-4-11:2004	For 50Hz: 0 % UT for 0.5cycle 40 % UT for 10cycles 70 % UT for 25cycles For 60Hz: 0 % UT for 0.5cycle 40 % UT for 12cycles 70 % UT for 30cycles UT is Supply Voltage	Pass
Conducted Immunity at Power Port (150kHz-230MHz)	EN 55014-2:2015	EN 61000-4-6:2014	3Vrms (emf),80%,1kHz Amp. Mod.	Pass



Unless otherwise agreed in writing, this document is issued by the Company subject to its General Conditions of Service printed overleaf, available on request or accessible at <http://www.sgs.com/en/Terms-and-Conditions.aspx> and, for electronic format documents, subject to Terms and Conditions for Electronic Documents at <http://www.sgs.com/en/Terms-and-Conditions/Terms-e-Documents.aspx>. Attention is drawn to the limitation of liability, indemnification and jurisdiction issues defined therein. Any holder of this document is advised that information contained hereon reflects the Company's findings at the time of its intervention only and within the limits of Client's instructions, if any. The Company's sole responsibility is to its Client and this document does not exonerate parties to a transaction from exercising all their rights and obligations under the transaction documents. This document cannot be reproduced except in full, without prior written approval of the Company. Any unauthorized alteration, forgery or falsification of the content or appearance of this document is unlawful and offenders may be prosecuted to the fullest extent of the law. Unless otherwise stated the results shown in this test report refer only to the sample(s) tested and such sample(s) are retained for 30 days only.
Attention: To check the authenticity of testing /inspection report & certificate, please contact us at telephone: (86-755) 8307 1443, or email: CN.Doccheck@sgs.com

3 Contents

	Page
1 Cover Page.....	1
2 Test Summary.....	3
3 Contents.....	4
4 General Information.....	6
4.1 Details of E.U.T.....	6
4.2 Description of Support Units.....	6
4.3 Measurement Uncertainty.....	6
4.4 Test Location.....	6
4.5 Test Facility.....	7
4.6 Deviation from Standards.....	8
4.7 Abnormalities from Standard Conditions.....	8
4.8 Monitoring of EUT for All Immunity Test.....	8
5 Equipment List.....	9
6 Emission Test Results.....	13
6.1 Conducted Emissions at Mains Terminals (150kHz-30MHz).....	13
6.1.1 E.U.T. Operation.....	13
6.1.2 Test Setup Diagram.....	13
6.1.3 Measurement Data.....	13
6.2 Radiated Emissions (30MHz-1GHz).....	16
6.2.1 E.U.T. Operation.....	16
6.2.2 Test Setup Diagram.....	16
6.2.3 Measurement Data.....	17
6.3 Harmonic Current Emission.....	19
6.3.1 E.U.T. Operation.....	19
6.3.2 Test Setup Diagram.....	19
6.3.3 Measurement Data.....	20
6.4 Voltage Fluctuations and Flicker.....	22
6.4.1 E.U.T. Operation.....	22
6.4.2 Test Setup Diagram.....	22
6.4.3 Measurement Data.....	23
7 Immunity Test Results.....	24
7.1 Performance Criteria Description in EN 55014-2:2015.....	24
7.2 Electrostatic Discharge.....	25
7.2.1 E.U.T. Operation.....	25
7.2.2 Test Setup Diagram.....	25
7.2.3 Test Results.....	26
7.3 Radiated Immunity (80MHz-1GHz).....	27
7.3.1 E.U.T. Operation.....	27
7.3.2 Test Setup Diagram.....	27
7.3.3 Test Results.....	28
7.4 Electrical Fast Transients/Burst at Power Port.....	29



Unless otherwise agreed in writing, this document is issued by the Company subject to its General Conditions of Service printed overleaf, available on request or accessible at <http://www.sgs.com/en/Terms-and-Conditions.aspx> and, for electronic format documents, subject to Terms and Conditions for Electronic Documents at <http://www.sgs.com/en/Terms-and-Conditions/Terms-e-Documents.aspx>. Attention is drawn to the limitation of liability, indemnification and jurisdiction issues defined therein. Any holder of this document is advised that information contained hereon reflects the Company's findings at the time of its intervention only and within the limits of Client's instructions, if any. The Company's sole responsibility is to its Client and this document does not exonerate parties to a transaction from exercising all their rights and obligations under the transaction documents. This document cannot be reproduced except in full, without prior written approval of the Company. Any unauthorized alteration, forgery or falsification of the content or appearance of this document is unlawful and offenders may be prosecuted to the fullest extent of the law. Unless otherwise stated the results shown in this test report refer only to the sample(s) tested and such sample(s) are retained for 30 days only.

Attention: To check the authenticity of testing /inspection report & certificate, please contact us at telephone: (86-755) 8307 1443, or email: CN.Doccheck@sgs.com

7.4.1	E.U.T. Operation.....	29
7.4.2	Test Setup Diagram.....	29
7.4.3	Test Results.....	29
7.5	Surge at Power Port.....	30
7.5.1	E.U.T. Operation.....	30
7.5.2	Test Setup Diagram.....	30
7.5.3	Test Results.....	30
7.6	Voltage Dips and Interruptions.....	31
7.6.1	E.U.T. Operation.....	31
7.6.2	Test Setup Diagram.....	31
7.6.3	Test Results.....	32
7.7	Conducted Immunity at Power Port (150kHz-230MHz).....	33
7.7.1	E.U.T. Operation.....	33
7.7.2	Test Setup Diagram.....	33
7.7.3	Test Results.....	33
8	Photographs.....	34
8.1	Conducted Emissions at Mains Terminals (150kHz-30MHz) Test Setup.....	34
8.2	Radiated Emissions (30MHz-1GHz) Test Setup.....	34
8.3	Harmonic Current Emission Test Setup.....	35
8.4	Voltage Fluctuations and Flicker Test Setup.....	36
8.5	Electrostatic Discharge Test Setup.....	37
8.6	Radiated Immunity (80MHz-1GHz) Test Setup.....	38
8.7	Electrical Fast Transients/Burst at Power Port Test Setup.....	39
8.8	Surge at Power Port Test Setup.....	40
8.9	Voltage Dips and Interruptions Test Setup.....	41
8.10	Conducted Immunity at Power Port (150kHz-230MHz) Test Setup.....	42
8.11	EUT Constructional Details.....	43



Unless otherwise agreed in writing, this document is issued by the Company subject to its General Conditions of Service printed overleaf, available on request or accessible at <http://www.sgs.com/en/Terms-and-Conditions.aspx> and, for electronic format documents, subject to Terms and Conditions for Electronic Documents at <http://www.sgs.com/en/Terms-and-Conditions/Terms-e-Documents.aspx>. Attention is drawn to the limitation of liability, indemnification and jurisdiction issues defined therein. Any holder of this document is advised that information contained hereon reflects the Company's findings at the time of its intervention only and within the limits of Client's instructions, if any. The Company's sole responsibility is to its Client and this document does not exonerate parties to a transaction from exercising all their rights and obligations under the transaction documents. This document cannot be reproduced except in full, without prior written approval of the Company. Any unauthorized alteration, forgery or falsification of the content or appearance of this document is unlawful and offenders may be prosecuted to the fullest extent of the law. Unless otherwise stated the results shown in this test report refer only to the sample(s) tested and such sample(s) are retained for 30 days only.
Attention: To check the authenticity of testing /inspection report & certificate, please contact us at telephone: (86-755) 8307 1443, or email: CN.Doccheck@sgs.com

4 General Information

4.1 Details of E.U.T.

Power Supply:	AC 220-240V 50/60Hz Controller power: DC 3V = 2 X DC 1.5V with size "AAA" batteries
Rated Power:	140W
Test Voltage:	AC 230V 50Hz
Cable:	3 wires x about 1.6m unscreened AC mains cable.

4.2 Description of Support Units

The EUT has been tested as an independent unit.

4.3 Measurement Uncertainty

No.	Item	Measurement Uncertainty
1	Conducted Disturbance Voltage at Mains Terminals	3.63dB (9kHz to 150kHz)
		3.22dB (150kHz to 30MHz)
2	Disturbance Power	3.78dB
3	Radiated Emissions	5.0dB (30MHz-1GHz)
		5.0dB (1GHz-6GHz)
4	Radiated Immunity	2.18dB(80MHz-3GHz)
5	Conducted Immunity	3.5dB(150kHz-230MHz)
6	Electrostatic Discharge	±6 %
7	EFT (Electrical Fast Transients)	±4 %
8	Surge Immunity	±6%
9	Voltage Dips and Interruptions	±4 %
10	CISPR 20 Immunity	1.5dB
11	Temperature	±0.4°C
12	Humidity	±1.3%
13	DC power	±0.5 %

4.4 Test Location

All tests were performed at:

SGS-CSTC Standards Technical Services Co., Ltd., Guangzhou Branch EMC Laboratory,
 198 Kezhu Road, Sciencetech Park, Guangzhou Economic & Technology Development District,
 Guangzhou, China 510663

Tel: +86 20 82155555 Fax: +86 20 82075059

No tests were sub-contracted.



Unless otherwise agreed in writing, this document is issued by the Company subject to its General Conditions of Service printed overleaf, available on request or accessible at <http://www.sgs.com/en/Terms-and-Conditions.aspx> and, for electronic format documents, subject to Terms and Conditions for Electronic Documents at <http://www.sgs.com/en/Terms-and-Conditions/Terms-e-Document.aspx>. Attention is drawn to the limitation of liability, indemnification and jurisdiction issues defined therein. Any holder of this document is advised that information contained hereon reflects the Company's findings at the time of its intervention only and within the limits of Client's instructions, if any. The Company's sole responsibility is to its Client and this document does not exonerate parties to a transaction from exercising all their rights and obligations under the transaction documents. This document cannot be reproduced except in full, without prior written approval of the Company. Any unauthorized alteration, forgery or falsification of the content or appearance of this document is unlawful and offenders may be prosecuted to the fullest extent of the law. Unless otherwise stated the results shown in this test report refer only to the sample(s) tested and such sample(s) are retained for 30 days only.
Attention: To check the authenticity of testing /inspection report & certificate, please contact us at telephone: (86-755) 8307 1443, or email: CN.Doccheck@sgs.com

4.5 Test Facility

The test facility is recognized, certified, or accredited by the following organizations:

● **NVLAP (Lab Code: 200611-0)**

SGS-CSTC Standards Technical Services Co., Ltd., Guangzhou EMC Laboratory is accredited by the National Voluntary Laboratory Accreditation Program (NVLAP/NIST). NVLAP Code: 200611-0.

The report must not be used by the client to claim product certification, approval, or endorsement by NVLAP, NIST, or any agency of the Federal Government.

● **ACMA**

SGS-CSTC Standards Technical Services Co., Ltd., EMC Laboratory can also perform testing for the Australian C-Tick mark as a result of our NVLAP accreditation.

● **SGS UK(Certificate No.: 32), SGS-TUV SAARLAND and SGS-FIMKO**

Have approved SGS-CSTC Standards Technical Services Co., Ltd., EMC Laboratory as a supplier of EMC TESTING SERVICES and SAFETY TESTING SERVICES.

● **CNAS (Lab Code: L0167)**

SGS-CSTC Standards Technical Services Co., Ltd., EMC Laboratory has been assessed and in compliance with CNAS-CL01:2018 accreditation criteria for testing laboratories (identical to ISO/IEC 17025:2017 General Requirements) for the Competence of Testing Laboratories.

● **FCC Recognized 2.948 Listed Test Firm(Registration No.: 282399)**

SGS-CSTC Standards Technical Services Co., Ltd., EMC Laboratory has been registered and fully described in a report filed with the (FCC) Federal Communications Commission. The acceptance letter from the FCC is maintained in our files. Registration 282399, May 31, 2002.

● **FCC Recognized Accredited Test Firm(Registration No.: 486818)**

SGS-CSTC Standards Technical Services Co., Ltd., EMC Laboratory has been accredited and fully described in a report filed with the (FCC) Federal Communications Commission. The acceptance letter from the FCC is maintained in our files. Designation Number: CN5016, Test Firm Registration Number: 486818, Jul 13, 2017.

● **Industry Canada (Registration No.: 4620B, CAB identifier: CN0052)**

SGS-CSTC Standards Technical Services Co., Ltd., has been registered by Innovation Science and Economic Development Canada for Wireless Device Testing laboratories to test to Canadian radio equipment requirements. Registration No. 4620B, CAB identifier: CN0052.

● **VCCI (Registration No.: R-12460, C-12584, G-10449 and T-11179)**

The 10m Semi-anechoic chamber and Shielded Room of SGS-CSTC Standards Technical Services Co., Ltd. Have been registered in accordance with the Regulations for Voluntary Control Measures with Registration No.: R-12460, C-12584, G-10449 and T-11179 respectively.

● **CBTL (Lab Code: TL129)**

SGS-CSTC Standards Technical Services Co., Ltd., E&E Laboratory has been assessed and fully comply with the requirements of ISO/IEC 17025:2005, the Basic Rules, IECEE 01 and Rules of procedure IECEE 02, and the relevant IECEE CB-Scheme Operational documents.



Unless otherwise agreed in writing, this document is issued by the Company subject to its General Conditions of Service printed overleaf, available on request or accessible at <http://www.sgs.com/en/Terms-and-Conditions.aspx> and, for electronic format documents, subject to Terms and Conditions for Electronic Documents at <http://www.sgs.com/en/Terms-and-Conditions/Terms-e-Documents.aspx>. Attention is drawn to the limitation of liability, indemnification and jurisdiction issues defined therein. Any holder of this document is advised that information contained hereon reflects the Company's findings at the time of its intervention only and within the limits of Client's instructions, if any. The Company's sole responsibility is to its Client and this document does not exonerate parties to a transaction from exercising all their rights and obligations under the transaction documents. This document cannot be reproduced except in full, without prior written approval of the Company. Any unauthorized alteration, forgery or falsification of the content or appearance of this document is unlawful and offenders may be prosecuted to the fullest extent of the law. Unless otherwise stated the results shown in this test report refer only to the sample(s) tested and such sample(s) are retained for 30 days only.
Attention: To check the authenticity of testing /inspection report & certificate, please contact us at telephone: (86-755) 8307 1443, or email: CN.Doccheck@sgs.com

4.6 Deviation from Standards

None.

4.7 Abnormalities from Standard Conditions

None

4.8 Monitoring of EUT for All Immunity Test

Visual: Motor running and LED display of the EUT.

Audio: N/A

Other: N/A



Unless otherwise agreed in writing, this document is issued by the Company subject to its General Conditions of Service printed overleaf, available on request or accessible at <http://www.sgs.com/en/Terms-and-Conditions.aspx> and, for electronic format documents, subject to Terms and Conditions for Electronic Documents at <http://www.sgs.com/en/Terms-and-Conditions/Terms-e-Documents.aspx>. Attention is drawn to the limitation of liability, indemnification and jurisdiction issues defined therein. Any holder of this document is advised that information contained hereon reflects the Company's findings at the time of its intervention only and within the limits of Client's instructions, if any. The Company's sole responsibility is to its Client and this document does not exonerate parties to a transaction from exercising all their rights and obligations under the transaction documents. This document cannot be reproduced except in full, without prior written approval of the Company. Any unauthorized alteration, forgery or falsification of the content or appearance of this document is unlawful and offenders may be prosecuted to the fullest extent of the law. Unless otherwise stated the results shown in this test report refer only to the sample(s) tested and such sample(s) are retained for 30 days only.

Attention: To check the authenticity of testing /inspection report & certificate, please contact us at telephone: (86-755) 8307 1443, or email: CN.Doccheck@sgs.com

5 Equipment List

Conducted Emissions at Mains Terminals (150kHz-30MHz)					
Equipment	Manufacturer	Model No	Inventory No	Cal Date	Cal Due Date
Shielding Room	ChangZhou ZhongYu	8m x 3m x 3.8m	EMC0306	N/A	N/A
Two-Line V-Network	Rohde & Schwarz	ENV216	EMC0118	2020-01-10	2021-01-09
LISN	Rohde & Schwarz	ENV216	EMC2135	2020-09-25	2021-09-24
EMI Test Receiver	Rohde & Schwarz	ESCS30	EMC0506	2019-11-18	2020-11-17
Coaxial Cable	HangTianXing	2m	EMC0107	2020-09-09	2022-09-08
Voltage Probe	SGS-EMC	N/A	EMC0106	2019-05-10	2021-05-09
Conical Metal Housing	SGS-EMC	N/A	EMC0167	2020-04-19	2022-04-18
Test Software E3c	Audix	Ver. 5.4.1221b	GZE100-62	N/A	N/A

Radiated Emissions (30MHz-1GHz)					
Equipment	Manufacturer	Model No	Inventory No	Cal Date	Cal Due Date
EMI Test Receiver	Rohde & Schwarz	ESIB26	EMC0522	2020-01-10	2021-01-09
EMI Test Receiver	Rohde & Schwarz	ESCI	EMC0056	2020-01-10	2021-01-09
Chamber cable	HangTianXing	N/A	EMC0542	2019-06-28	2021-06-27
Trilog Broadband Antenna 25MHz-1GHz	SCHWARZBECKME SS-ELEKTRONIK	VULB 9168	EMC2174	2018-09-06	2021-09-05
Trilog Broadband Antenna 30MHz-1GHz	SCHWARZBECKME SS-ELEKTRONIK	VULB 9168	SEM003-18	2019-02-22	2022-02-22
Bi-log Type Antenna	Schaffner Chase	CBL6143	EMC0519	2020-06-08	2023-06-07
Horn Antenna 1GHz-18GHz	Rohde & Schwarz	HF906	EMC0518	2018-09-02	2021-09-01
1GHz-26.5 GHz Pre-Amplifier	Agilent	8449B	EMC0521	2020-01-10	2021-01-09
Amplifier	HP	8447F	EMC2065	2020-05-26	2021-05-25
Pre-Amplifier MH648A	ANRITSU CORP	MH648A	EMC2086	2019-11-18	2020-11-17
Active Loop Antenna	ETS-Lindgren	6502	EMC2190	2019-12-27	2021-12-26
High Pass Filter(915MHz)	FSY MICROWAVE	HM1465-9SS	EMC2079	2020-01-10	2021-01-09
2.4GHz Filter	Micro-Tronics	BRM 50702	EMC2069	2020-01-10	2021-01-09
10m Semi-Anechoic Chamber	ETS	N/A	EMC0530	2019-10-20	2022-10-19
966 Anechoic Chamber	C.R.T	9m x 6m x 6m	EMC2142	2017-12-19	2020-12-18
MXE EMI Receiver	Keysight	N9038A	EMC2139	2019-11-18	2020-11-17
EXA Signal Analyzer	Keysight	N9010A	EMC2138	2019-11-18	2020-11-17
Test Software E3	Audix	Ver.6.120110a	GZE100-61	N/A	N/A



Unless otherwise agreed in writing, this document is issued by the Company subject to its General Conditions of Service printed overleaf, available on request or accessible at <http://www.sgs.com/en/Terms-and-Conditions.aspx> and, for electronic format documents, subject to Terms and Conditions for Electronic Documents at <http://www.sgs.com/en/Terms-and-Conditions/Terms-e-Documents.aspx>. Attention is drawn to the limitation of liability, indemnification and jurisdiction issues defined therein. Any holder of this document is advised that information contained hereon reflects the Company's findings at the time of its intervention only and within the limits of Client's instructions, if any. The Company's sole responsibility is to its Client and this document does not exonerate parties to a transaction from exercising all their rights and obligations under the transaction documents. This document cannot be reproduced except in full, without prior written approval of the Company. Any unauthorized alteration, forgery or falsification of the content or appearance of this document is unlawful and offenders may be prosecuted to the fullest extent of the law. Unless otherwise stated the results shown in this test report refer only to the sample(s) tested and such sample(s) are retained for 30 days only.

Attention: To check the authenticity of testing /inspection report & certificate, please contact us at telephone: (86-755) 8307 1443, or email: CN.Doccheck@sgs.com

Harmonic Current Emission					
Equipment	Manufacturer	Model No	Inventory No	Cal Date	Cal Due Date
AC Power Source	California	50001iX	EMC0608	2020-03-27	2021-03-26
Power Analyzer	California	PACS	EMC0607	2020-03-27	2021-03-26
Test Software CTS4	California	Ver 4.14.0	GZE100-66	N/A	N/A

Voltage Fluctuations and Flicker					
Equipment	Manufacturer	Model No	Inventory No	Cal Date	Cal Due Date
AC Power Source	California	50001iX	EMC0608	2020-03-27	2021-03-26
Power Analyzer	California	PACS	EMC0607	2020-03-27	2021-03-26
Test Software CTS4	California	Ver 4.14.0	GZE100-66	N/A	N/A

Electrostatic Discharge					
Equipment	Manufacturer	Model No	Inventory No	Cal Date	Cal Due Date
ESD Simulator	TESEQ AG	NSG 435	EMC2071	2020-06-30	2021-06-30
ESD Simulator	EMTEST	NX30	EMC2186	2020-03-02	2021-03-01
ESD Ground Plane	SGS-EMC	3m x 3m	EMC0804	N/A	N/A
Temperature & Humidity	Shanghai Meteorological Instrument Factory Co., Ltd.	ZJ1-2B	EMC0078	2020-07-04	2021-07-03



Unless otherwise agreed in writing, this document is issued by the Company subject to its General Conditions of Service printed overleaf, available on request or accessible at <http://www.sgs.com/en/Terms-and-Conditions.aspx> and, for electronic format documents, subject to Terms and Conditions for Electronic Documents at <http://www.sgs.com/en/Terms-and-Conditions/Terms-e-Documents.aspx>. Attention is drawn to the limitation of liability, indemnification and jurisdiction issues defined therein. Any holder of this document is advised that information contained hereon reflects the Company's findings at the time of its intervention only and within the limits of Client's instructions, if any. The Company's sole responsibility is to its Client and this document does not exonerate parties to a transaction from exercising all their rights and obligations under the transaction documents. This document cannot be reproduced except in full, without prior written approval of the Company. Any unauthorized alteration, forgery or falsification of the content or appearance of this document is unlawful and offenders may be prosecuted to the fullest extent of the law. Unless otherwise stated the results shown in this test report refer only to the sample(s) tested and such sample(s) are retained for 30 days only.

Attention: To check the authenticity of testing /inspection report & certificate, please contact us at telephone: (86-755) 8307 1443, or email: CN.Doccheck@sgs.com

Radiated Immunity (80MHz-1GHz)					
Equipment	Manufacturer	Model No	Inventory No	Cal Date	Cal Due Date
Compact 3m Semi-Anechoic Chamber	ChangZhou ZhongYu	N/A	EMC0525	2019-10-20	2022-10-19
Laser Probe Interface	RF Microwave Instrumentation	FI7000	EMC2089	N/A	N/A
Open Switch And Control Unit	Rohde & Schwarz	OSP130	EMC2090	N/A	N/A
Broadband Amplifier(80MHz~1GHz/250W)	Rohde & Schwarz	BBA150	EMC2091	2020-01-10	2021-01-09
Broadband Amplifier(800MHz~3GHz/110W)	Rohde & Schwarz	BBA150	EMC2092	2020-01-10	2021-01-09
Signal Generator	Rohde & Schwarz	SMB100A	EMC2093	2020-01-10	2021-01-09
Laser Probe	RF Microwave Instrumentation	FL7006	EMC2094	2020-03-02	2021-03-21
NRP-Z91 Power Sensor 6GHz	Rohde & Schwarz	NPR-Z91	EMC2095	2020-01-10	2021-01-09
NRP-Z91 Power Sensor 6GHz	Rohde & Schwarz	NPR-Z91	EMC2096	2020-01-10	2021-01-09
High-Gain Log-preiodic Antenna	Rohde & Schwarz	HL046E	EMC2097	2019-02-15	2022-02-14
Stacked Logarithmic-Periodic Broadband Antenna (0.7~9GHz)/300W	SCHWARZBECK MESS – ELEKTRONIK	STLP 9149	SEM003-21	2018-09-18	2021-09-17
Broadband Amplifier (2.5~6GHz/30W)	Rohde & Schwarz	BBA150	EMC2105	2020-09-18	2021-09-17
RI Cable	Rohde & Schwarz	7m	EMC2098	2020-05-24	2021-05-23
Oscilloscope	Tektronix	TDS3052C	EMC2055	2020-01-10	2021-01-09
Audio Analyzer	Keysight	U8903B	EMC2180	2020-09-18	2021-09-17
Monitor System	Mitsubish Corp.	M-0552AB	EMC0909	N/A	N/A
Test Software EMC32	Rohde & Schwarz	Ver. 9.26.00	GZE100-63	N/A	N/A

Electrical Fast Transients/Burst at Power Port					
Equipment	Manufacturer	Model No	Inventory No	Cal Date	Cal Due Date
EMC Immunity Test System	TESEQ AG	NSG 3060CDN30611 NA 6502 CIBCND3425	EMC2072	2020-01-10	2021-01-09
Oscilloscope	Tektronix	TDS3052C	EMC2055	2020-01-10	2021-01-09
Test Software WIN 3000	TESEQ AG	Ver 1.3.2	GZE100-68	N/A	N/A



Unless otherwise agreed in writing, this document is issued by the Company subject to its General Conditions of Service printed overleaf, available on request or accessible at <http://www.sgs.com/en/Terms-and-Conditions.aspx> and, for electronic format documents, subject to Terms and Conditions for Electronic Documents at <http://www.sgs.com/en/Terms-and-Conditions/Terms-e-Documents.aspx>. Attention is drawn to the limitation of liability, indemnification and jurisdiction issues defined therein. Any holder of this document is advised that information contained hereon reflects the Company's findings at the time of its intervention only and within the limits of Client's instructions, if any. The Company's sole responsibility is to its Client and this document does not exonerate parties to a transaction from exercising all their rights and obligations under the transaction documents. This document cannot be reproduced except in full, without prior written approval of the Company. Any unauthorized alteration, forgery or falsification of the content or appearance of this document is unlawful and offenders may be prosecuted to the fullest extent of the law. Unless otherwise stated the results shown in this test report refer only to the sample(s) tested and such sample(s) are retained for 30 days only.

Attention: To check the authenticity of testing /inspection report & certificate, please contact us at telephone: (86-755) 8307 1443, or email: CN.Doccheck@sgs.com

Surge at Power Port					
Equipment	Manufacturer	Model No	Inventory No	Cal Date	Cal Due Date
Modular Impulse Surge Generator	EMC PARTNER	MIG0603EN	EMC2059	2020-01-10	2021-01-09
EMC Immunity Test System	TESEQ AG	NSG 3060CDN30611 NA 6502 CIBCND3425	EMC2072	2020-01-10	2021-01-09
Oscilloscope	Tektronix	TDS3052C	EMC2055	2020-01-10	2021-01-09
Test Software WIN 3000	TESEQ AG	Ver 1.3.2	GZE100-68	N/A	N/A

Voltage Dips and Interruptions					
Equipment	Manufacturer	Model No	Inventory No	Cal Date	Cal Due Date
EMC Immunity Test System	TESEQ AG	NSG 3060CDN30611 NA 6502 CIBCND3425	EMC2072	2020-01-10	2021-01-09
Oscilloscope	Tektronix	TDS3052C	EMC2055	2020-01-10	2021-01-09
Test Software WIN 3000	TESEQ AG	Ver 1.3.2	GZE100-68	N/A	N/A

Conducted Immunity at Power Port (150kHz-230MHz)					
Equipment	Manufacturer	Model No	Inventory No	Cal Date	Cal Due Date
Test System for Conducted and Radiated Immunity	TESEQ AG	NSG 4070B-80	EMC2115	2019-12-03	2020-12-02
Test Software NSG4070_Ctrl1	TESEQ AG	Ver.1.3.0.1	GZE100-72	N/A	N/A
CDN S502A	TESEQ AG	CDN S502A	EMC2113	2019-07-13	2021-07-12
CDN ST08A	TESEQ AG	CDN ST08A	EMC2112	2019-07-13	2021-07-12
CDN USB3.0	TESEQ AG	CDN USB3.0	EMC2114	2019-07-13	2021-07-12
Dual Directional coupler	Werlatone Inc.	C1795	EMC1105	2020-05-26	2021-05-25
Oscilloscope	Tektronix	TDS3052C	EMC2055	2020-01-10	2021-01-09
CDN	Elektronik-Feinmechanik	L-801:M2/M3	EMC2048	2020-08-21	2022-08-20
CDN M2	Schaffner Chase	CDN-M2-16	EMC1107	2017-10-26	2020-10-25
Current Probe	Schaffner Chase	CIP9136	EMC1116	2017-10-26	2020-10-25
Current Probe	Schaffner Chase	CSP8445	EMC1117	2017-10-26	2020-10-25
Audio Analyzer	Keysight	U8903B	EMC2180	2020-09-18	2021-09-17

General used equipment					
Equipment	Manufacturer	Model No	Inventory No	Cal Date	Cal Due Date
DMM	Fluke	73	EMC0006	2020-07-09	2021-07-08
DMM	Fluke	73	EMC0007	2020-07-09	2021-07-08



Unless otherwise agreed in writing, this document is issued by the Company subject to its General Conditions of Service printed overleaf, available on request or accessible at <http://www.sgs.com/en/Terms-and-Conditions.aspx> and, for electronic format documents, subject to Terms and Conditions for Electronic Documents at <http://www.sgs.com/en/Terms-and-Conditions/Terms-e-Documents.aspx>. Attention is drawn to the limitation of liability, indemnification and jurisdiction issues defined therein. Any holder of this document is advised that information contained hereon reflects the Company's findings at the time of its intervention only and within the limits of Client's instructions, if any. The Company's sole responsibility is to its Client and this document does not exonerate parties to a transaction from exercising all their rights and obligations under the transaction documents. This document cannot be reproduced except in full, without prior written approval of the Company. Any unauthorized alteration, forgery or falsification of the content or appearance of this document is unlawful and offenders may be prosecuted to the fullest extent of the law. Unless otherwise stated the results shown in this test report refer only to the sample(s) tested and such sample(s) are retained for 30 days only.

Attention: To check the authenticity of testing /inspection report & certificate, please contact us at telephone: (86-755) 8307 1443, or email: CN.Doccheck@sgs.com

6 Emission Test Results

6.1 Conducted Emissions at Mains Terminals (150kHz-30MHz)

Test Requirement:	EN 55014-1:2017
Test Method:	CISPR 16-2-1
Frequency Range:	150kHz to 30MHz
Limit:	
0.15M-0.5MHz	66dB(μV)-56dB(μV) quasi-peak, 59dB(μV)-46dB(μV) average
0.5M-5MHz	56dB(μV) quasi-peak, 46dB(μV) average
5M-30MHz	60dB(μV) quasi-peak, 50dB(μV) average
Detector:	Peak for pre-scan (9kHz resolution bandwidth) 0.15M to 30MHz

6.1.1 E.U.T. Operation

Operating Environment:

Temperature: 25 °C Humidity: 52 % RH Atmospheric Pressure: 1020 mbar

Pretest these modes to find the worst case:

- a: Test the EUT in Motor running mode with max output power & LED display,
- b: Test the EUT in Motor running mode with middle output power & LED display.
- C: Test the EUT in Motor running mode with lowest output power & LED display.

The worst case for final test: a: Test the EUT in Motor running mode with max output power & LED display,

6.1.2 Test Setup Diagram

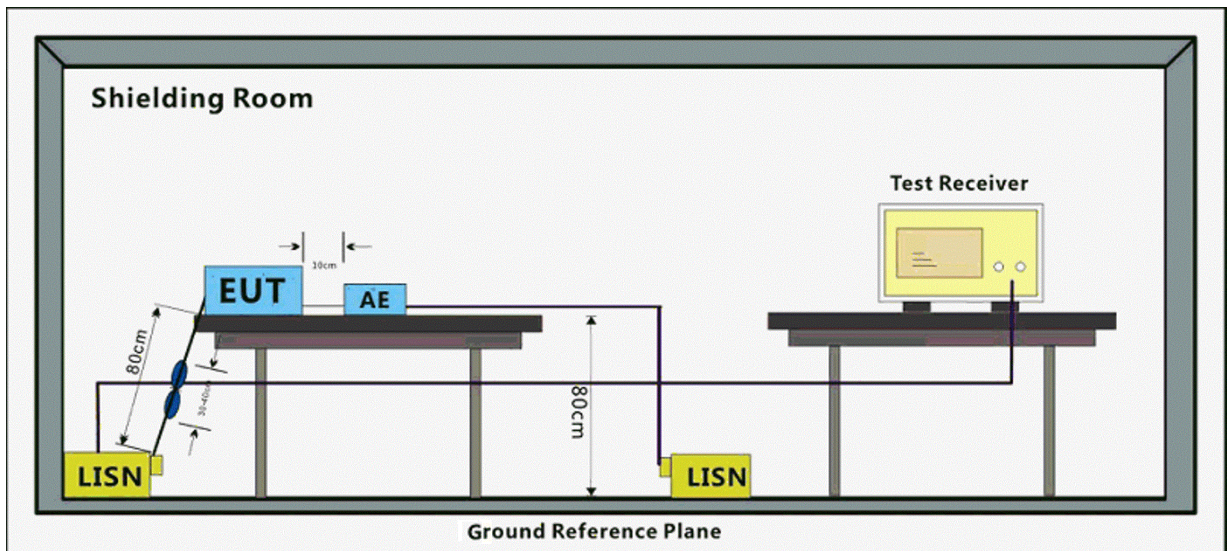

6.1.3 Measurement Data

An initial pre-scan was performed with peak detector. Quasi-Peak or Average measurement were performed at the frequencies with maximized peak emission were detected.

Measured Level = Read level + Cable Loss + LISN Factor



Unless otherwise agreed in writing, this document is issued by the Company subject to its General Conditions of Service printed overleaf, available on request or accessible at <http://www.sgs.com/en/Terms-and-Conditions.aspx> and, for electronic format documents, subject to Terms and Conditions for Electronic Documents at <http://www.sgs.com/en/Terms-and-Conditions/Terms-e-Documents.aspx>. Attention is drawn to the limitation of liability, indemnification and jurisdiction issues defined therein. Any holder of this document is advised that information contained hereon reflects the Company's findings at the time of its intervention only and within the limits of Client's instructions, if any. The Company's sole responsibility is to its Client and this document does not exonerate parties to a transaction from exercising all their rights and obligations under the transaction documents. This document cannot be reproduced except in full, without prior written approval of the Company. Any unauthorized alteration, forgery or falsification of the content or appearance of this document is unlawful and offenders may be prosecuted to the fullest extent of the law. Unless otherwise stated the results shown in this test report refer only to the sample(s) tested and such sample(s) are retained for 30 days only.
Attention: To check the authenticity of testing /inspection report & certificate, please contact us at telephone: (86-755) 8307 1443, or email: CN.Doccheck@sgs.com

Mode:a; Line:Live Line

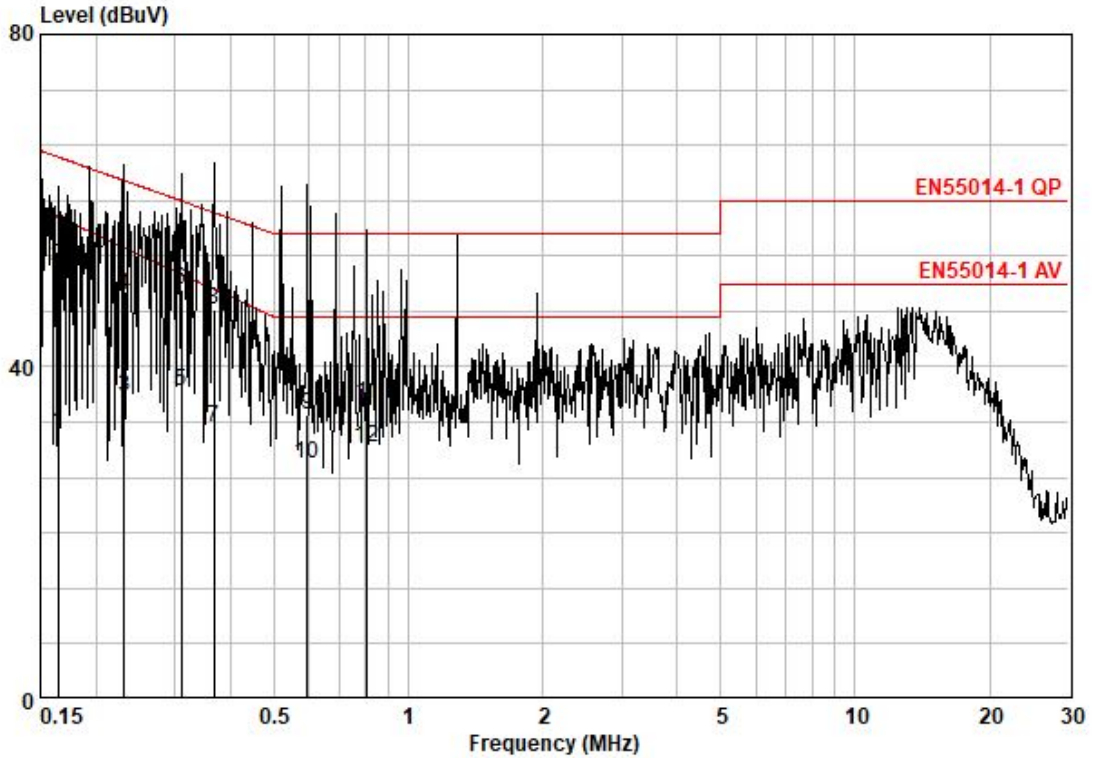

Pol :LIVE
Mode :
Model :

Frequency MHz	read level dBuV	Cable Loss dB	LISN Factor dB	Measured level dBuV	Limit Line dBuV	Over limit dB	Remark
0.16	22.27	0.10	9.61	31.98	58.03	-26.05	AVERAGE
0.16	42.48	0.10	9.61	52.19	65.25	-13.06	QP
0.23	26.74	0.10	9.61	36.45	54.31	-17.86	AVERAGE
0.23	38.82	0.10	9.61	48.53	62.39	-13.86	QP
0.31	27.37	0.10	9.60	37.07	51.16	-14.09	AVERAGE
0.31	39.57	0.10	9.60	49.27	59.97	-10.70	QP
0.37	23.05	0.10	9.60	32.75	49.33	-16.58	AVERAGE
0.37	37.14	0.10	9.60	46.84	58.56	-11.72	QP
0.59	24.61	0.10	9.61	34.32	56.00	-21.68	QP
0.59	18.71	0.10	9.61	28.42	46.00	-17.58	AVERAGE
0.81	25.74	0.10	9.61	35.45	56.00	-20.55	QP
0.81	20.49	0.10	9.61	30.20	46.00	-15.80	AVERAGE



Unless otherwise agreed in writing, this document is issued by the Company subject to its General Conditions of Service printed overleaf, available on request or accessible at <http://www.sgs.com/en/Terms-and-Conditions.aspx> and, for electronic format documents, subject to Terms and Conditions for Electronic Documents at <http://www.sgs.com/en/Terms-and-Conditions/Terms-e-Document.aspx>. Attention is drawn to the limitation of liability, indemnification and jurisdiction issues defined therein. Any holder of this document is advised that information contained hereon reflects the Company's findings at the time of its intervention only and within the limits of Client's instructions, if any. The Company's sole responsibility is to its Client and this document does not exonerate parties to a transaction from exercising all their rights and obligations under the transaction documents. This document cannot be reproduced except in full, without prior written approval of the Company. Any unauthorized alteration, forgery or falsification of the content or appearance of this document is unlawful and offenders may be prosecuted to the fullest extent of the law. Unless otherwise stated the results shown in this test report refer only to the sample(s) tested and such sample(s) are retained for 30 days only.

Mode:a; Line:Neutral Line

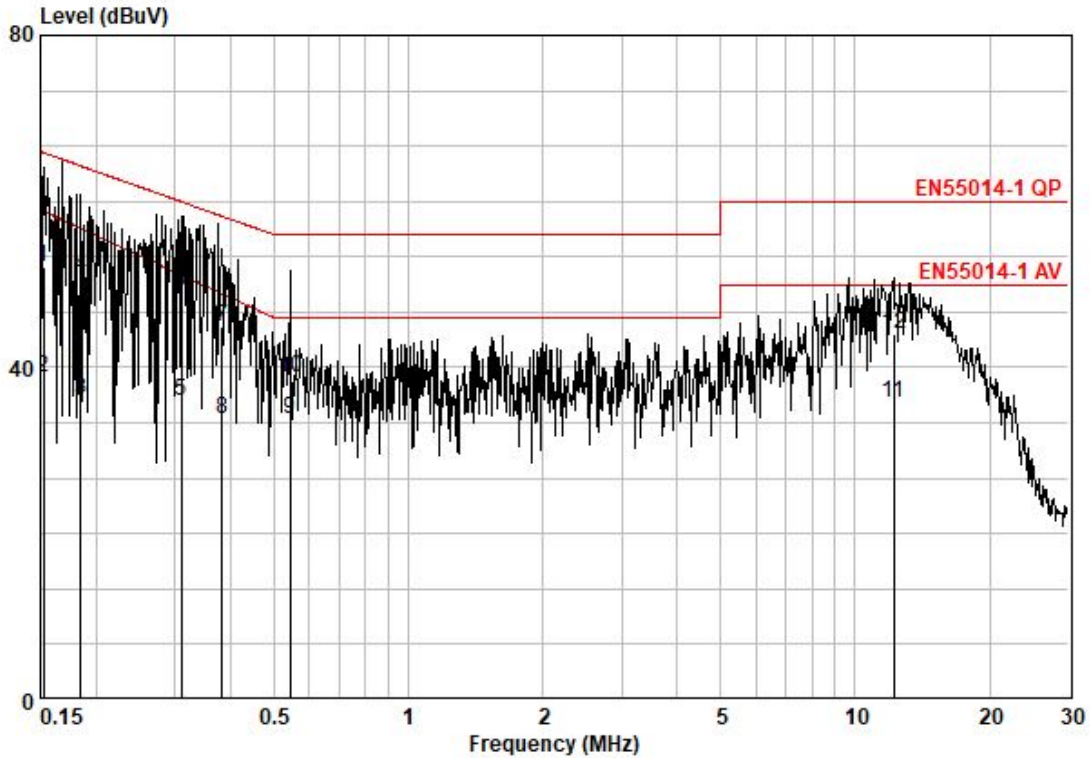

Pol : NEUTRAL
Mode :
Model :

Frequency MHz	read level dBuV	Cable Loss dB	LISN Factor dB	Measured level dBuV	Limit Line dBuV	Over limit dB	Remark
0.15	42.28	0.10	9.61	51.99	65.87	-13.88	QP
0.15	29.16	0.10	9.61	38.87	58.83	-19.96	AVERAGE
0.18	26.37	0.10	9.62	36.09	56.77	-20.68	AVERAGE
0.18	41.22	0.10	9.62	50.94	64.28	-13.34	QP
0.31	26.27	0.10	9.63	36.00	51.16	-15.16	AVERAGE
0.31	39.22	0.10	9.63	48.95	59.97	-11.02	QP
0.38	35.26	0.10	9.64	45.00	58.21	-13.21	QP
0.38	23.98	0.10	9.64	33.72	48.87	-15.16	AVERAGE
0.54	24.12	0.10	9.64	33.86	46.00	-12.14	AVERAGE
0.54	29.07	0.10	9.64	38.81	56.00	-17.19	QP
12.19	25.35	0.30	10.03	35.68	50.00	-14.32	AVERAGE
12.19	33.64	0.30	10.03	43.97	60.00	-16.03	QP



Unless otherwise agreed in writing, this document is issued by the Company subject to its General Conditions of Service printed overleaf, available on request or accessible at <http://www.sgs.com/en/Terms-and-Conditions.aspx> and, for electronic format documents, subject to Terms and Conditions for Electronic Documents at <http://www.sgs.com/en/Terms-and-Conditions/Terms-e-Document.aspx>. Attention is drawn to the limitation of liability, indemnification and jurisdiction issues defined therein. Any holder of this document is advised that information contained hereon reflects the Company's findings at the time of its intervention only and within the limits of Client's instructions, if any. The Company's sole responsibility is to its Client and this document does not exonerate parties to a transaction from exercising all their rights and obligations under the transaction documents. This document cannot be reproduced except in full, without prior written approval of the Company. Any unauthorized alteration, forgery or falsification of the content or appearance of this document is unlawful and offenders may be prosecuted to the fullest extent of the law. Unless otherwise stated the results shown in this test report refer only to the sample(s) tested and such sample(s) are retained for 30 days only.

Attention: To check the authenticity of testing / inspection report & certificate, please contact us at telephone: (86-755) 8307 1443, or email: CN.Doccheck@sgs.com

6.2 Radiated Emissions (30MHz-1GHz)

Test Requirement: EN 55014-1:2017
 Test Method: CISPR 16-2-3
 Frequency Range: 30MHz to 1GHz
 Measurement Distance: 10m
 Limit:
 30MHz-230MHz 30 dB(μV/m) quasi-peak
 230MHz-1GHz 37 dB(μV/m) quasi-peak
 Detector: Peak for pre-scan (120kHz resolution bandwidth) 30M to 1000MHz

6.2.1 E.U.T. Operation

Operating Environment:
 Temperature: 21 °C Humidity: 51 % RH Atmospheric Pressure: 1020 mbar
 Pretest these modes to find the worst case:
 a: Test the EUT in Motor running mode with max output power & LED display,
 b: Test the EUT in Motor running mode with middle output power & LED display.
 C: Test the EUT in Motor running mode with lowest output power & LED display.
 E: Test the EUT in continuously transmitting mode.
 The worst case for final test:
 a: Test the EUT in Motor running mode with max output power & LED display,

6.2.2 Test Setup Diagram

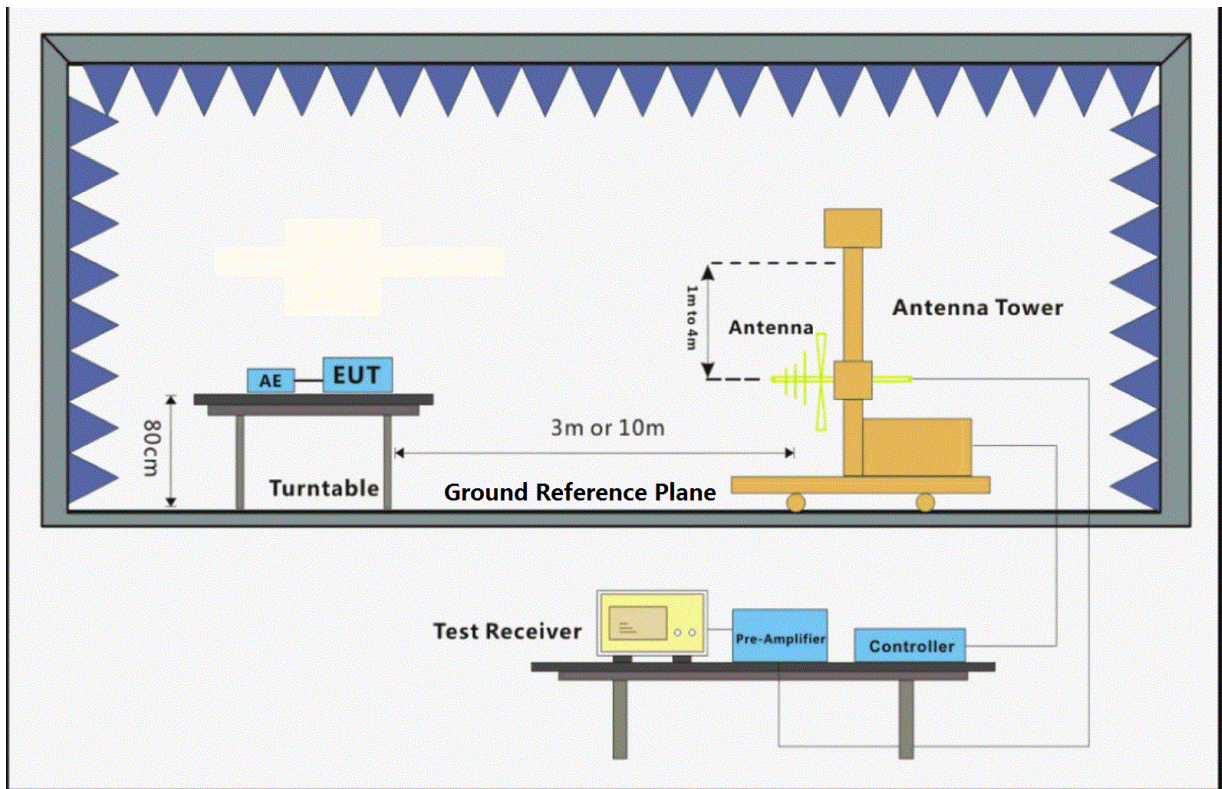

Unless otherwise agreed in writing, this document is issued by the Company subject to its General Conditions of Service printed overleaf, available on request or accessible at <http://www.sgs.com/en/Terms-and-Conditions.aspx> and, for electronic format documents, subject to Terms and Conditions for Electronic Documents at <http://www.sgs.com/en/Terms-and-Conditions/Terms-e-Document.aspx>. Attention is drawn to the limitation of liability, indemnification and jurisdiction issues defined therein. Any holder of this document is advised that information contained hereon reflects the Company's findings at the time of its intervention only and within the limits of Client's instructions, if any. The Company's sole responsibility is to its Client and this document does not exonerate parties to a transaction from exercising all their rights and obligations under the transaction documents. This document cannot be reproduced except in full, without prior written approval of the Company. Any unauthorized alteration, forgery or falsification of the content or appearance of this document is unlawful and offenders may be prosecuted to the fullest extent of the law. Unless otherwise stated the results shown in this test report refer only to the sample(s) tested and such sample(s) are retained for 30 days only.

6.2.3 Measurement Data

An initial pre-scan was performed in the chamber using the spectrum analyser in peak detection mode. Quasi-peak measurements were conducted based on the peak sweep graph. The EUT was measured by BiConiLog antenna with 2 orthogonal polarities.

Level=Read Level + Antenna Factor + Cable Loss – Preamp Factor

Mode:a; Polarization:Horizontal

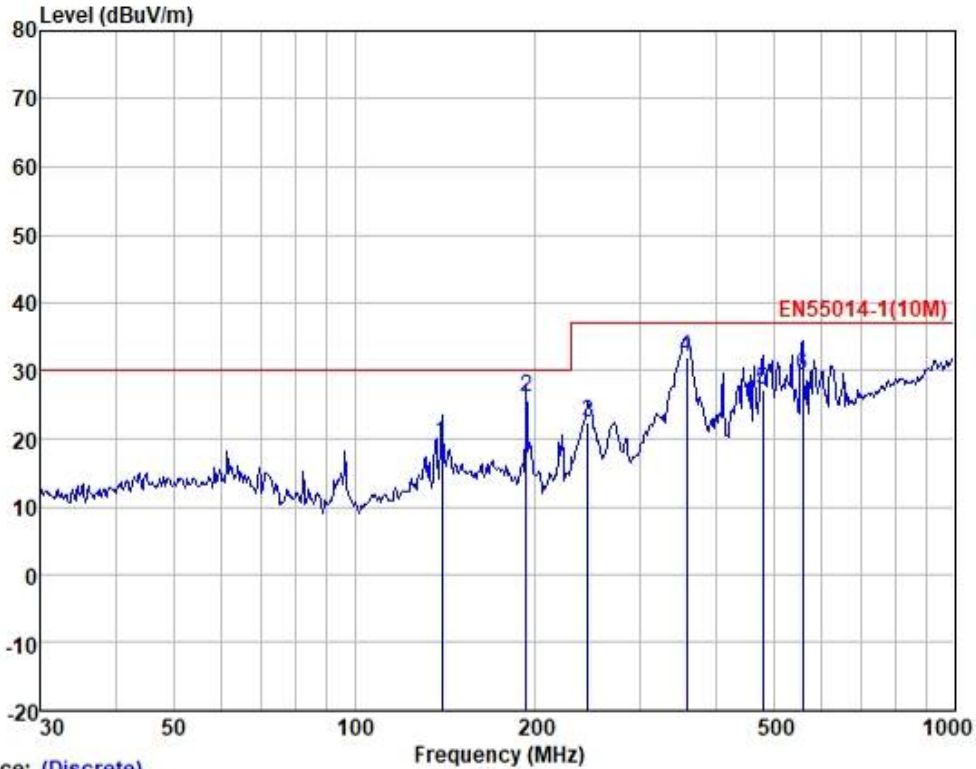

Trace: (Discrete)
 Site : SGS
 Condition: EN55014-1(10M) 10m HORIZONTAL
 Job :
 Model :
 Power :
 Test Mode:

	Freq	ReadLevel	Antenna Factor	Cable Loss	Preamp Factor	Level	Limit Line	Over Limit	Pol/Phase	Remark
	MHz	dBuV	dB/m	dB	dB	dBuV/m	dBuV/m	dB		
1	139.851	31.11	13.30	1.97	26.93	19.45	30.00	-10.55	HORIZONTAL	QP
2	193.095	39.45	10.83	2.46	26.74	26.00	30.00	-4.00	HORIZONTAL	QP
3	245.090	34.45	12.00	2.68	26.64	22.49	37.00	-14.51	HORIZONTAL	QP
4	357.929	40.98	14.75	3.28	27.09	31.92	37.00	-5.08	HORIZONTAL	QP
5	478.846	33.39	17.57	4.08	27.90	27.14	37.00	-9.86	HORIZONTAL	QP
6	558.730	34.27	18.78	4.55	28.13	29.47	37.00	-7.53	HORIZONTAL	QP



Unless otherwise agreed in writing, this document is issued by the Company subject to its General Conditions of Service printed overleaf, available on request or accessible at <http://www.sgs.com/en/Terms-and-Conditions.aspx> and, for electronic format documents, subject to Terms and Conditions for Electronic Documents at <http://www.sgs.com/en/Terms-and-Conditions/Terms-e-Documents.aspx>. Attention is drawn to the limitation of liability, indemnification and jurisdiction issues defined therein. Any holder of this document is advised that information contained hereon reflects the Company's findings at the time of its intervention only and within the limits of Client's instructions, if any. The Company's sole responsibility is to its Client and this document does not exonerate parties to a transaction from exercising all their rights and obligations under the transaction documents. This document cannot be reproduced except in full, without prior written approval of the Company. Any unauthorized alteration, forgery or falsification of the content or appearance of this document is unlawful and offenders may be prosecuted to the fullest extent of the law. Unless otherwise stated the results shown in this test report refer only to the sample(s) tested and such sample(s) are retained for 30 days only.

Mode:a; Polarization:Vertical

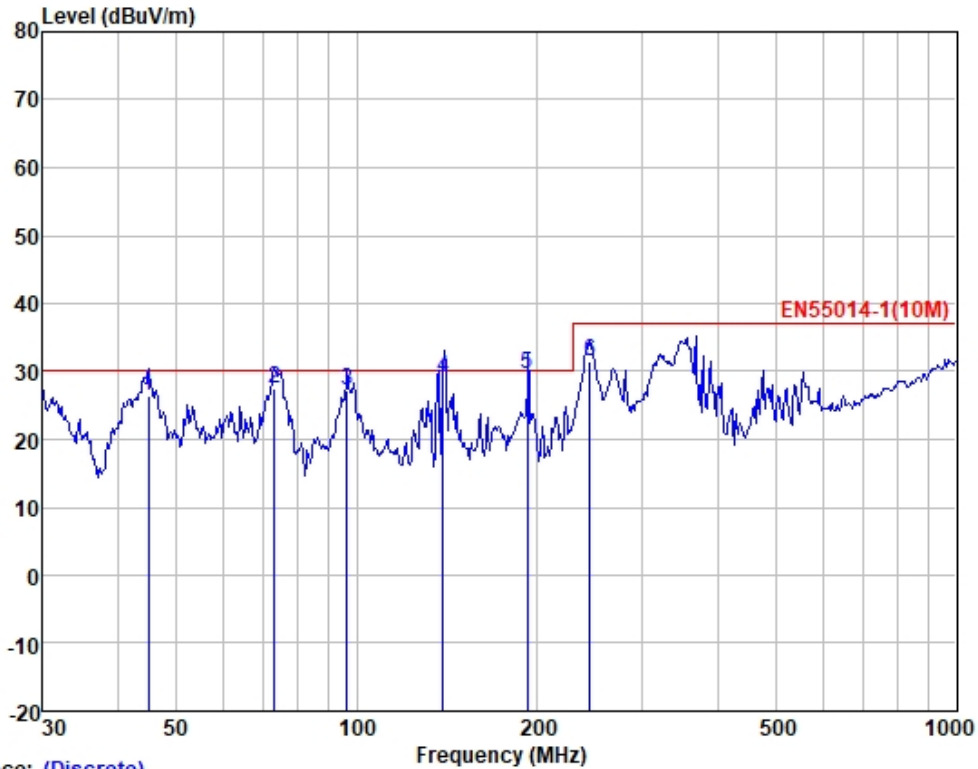

Trace: (Discrete)
 Site : SGS
 Condition: EN55014-1(10M) 10m VERTICAL
 Job : F
 Model :
 Power :
 Test Mode:

	ReadAntenna	Cable Preamp	Limit	Over					
Freq	Level	Factor	Loss	Factor	Level	Line	Limit	Pol/Phase	Remark
MHz	dBuV	dB/m	dB	dB	dBuV/m	dBuV/m	dB		
1	45.058	38.59	13.85	1.19	27.17	26.46	30.00	-3.54	VERTICAL QP
2	72.847	41.86	11.28	1.43	27.11	27.46	30.00	-2.54	VERTICAL QP
3	96.436	43.95	8.63	1.61	27.08	27.11	30.00	-2.89	VERTICAL QP
4	139.146	40.91	13.23	1.96	26.93	29.17	30.00	-0.83	VERTICAL QP
5	192.602	42.91	10.87	2.46	26.74	29.50	30.00	-0.50	VERTICAL QP
6	245.090	43.39	12.00	2.68	26.64	31.43	37.00	-5.57	VERTICAL QP



Unless otherwise agreed in writing, this document is issued by the Company subject to its General Conditions of Service printed overleaf, available on request or accessible at <http://www.sgs.com/en/Terms-and-Conditions.aspx> and, for electronic format documents, subject to Terms and Conditions for Electronic Documents at <http://www.sgs.com/en/Terms-and-Conditions/Terms-e-Documents.aspx>. Attention is drawn to the limitation of liability, indemnification and jurisdiction issues defined therein. Any holder of this document is advised that information contained hereon reflects the Company's findings at the time of its intervention only and within the limits of Client's instructions, if any. The Company's sole responsibility is to its Client and this document does not exonerate parties to a transaction from exercising all their rights and obligations under the transaction documents. This document cannot be reproduced except in full, without prior written approval of the Company. Any unauthorized alteration, forgery or falsification of the content or appearance of this document is unlawful and offenders may be prosecuted to the fullest extent of the law. Unless otherwise stated the results shown in this test report refer only to the sample(s) tested and such sample(s) are retained for 30 days only.
 Attention: To check the authenticity of testing /inspection report & certificate, please contact us at telephone: (86-755) 8307 1443, or email: CN.Doccheck@sgs.com

6.3 Harmonic Current Emission

Test Requirement: EN IEC 61000-3-2:2019
 Test Method: EN IEC 61000-3-2:2019
 Frequency Range: 100Hz to 2kHz

6.3.1 E.U.T. Operation

Operating Environment:

Temperature: 25.3 °C Humidity: 52 % RH Atmospheric Pressure: 1020 mbar

Pretest these modes to find the worst case:
 a: Test the EUT in Motor running mode with max output power & LED display,
 b: Test the EUT in Motor running mode with middle output power & LED display.
 C: Test the EUT in Motor running mode with lowest output power & LED display.
 D: Test the EUT in standby mode.

The worst case for final test: a: Test the EUT in Motor running mode with max output power & LED display,

6.3.2 Test Setup Diagram

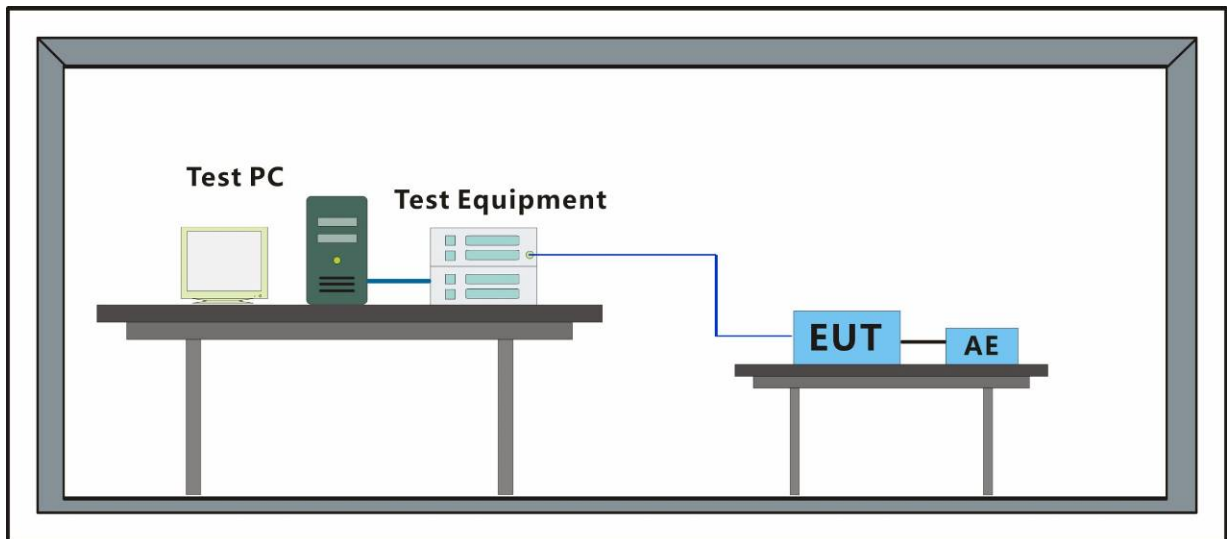

Unless otherwise agreed in writing, this document is issued by the Company subject to its General Conditions of Service printed overleaf, available on request or accessible at <http://www.sgs.com/en/Terms-and-Conditions.aspx> and, for electronic format documents, subject to Terms and Conditions for Electronic Documents at <http://www.sgs.com/en/Terms-and-Conditions/Terms-e-Document.aspx>. Attention is drawn to the limitation of liability, indemnification and jurisdiction issues defined therein. Any holder of this document is advised that information contained hereon reflects the Company's findings at the time of its intervention only and within the limits of Client's instructions, if any. The Company's sole responsibility is to its Client and this document does not exonerate parties to a transaction from exercising all their rights and obligations under the transaction documents. This document cannot be reproduced except in full, without prior written approval of the Company. Any unauthorized alteration, forgery or falsification of the content or appearance of this document is unlawful and offenders may be prosecuted to the fullest extent of the law. Unless otherwise stated the results shown in this test report refer only to the sample(s) tested and such sample(s) are retained for 30 days only.
Attention: To check the authenticity of testing /inspection report & certificate, please contact us at telephone: (86-755) 8307 1443, or email: CN.Doccheck@sgs.com

6.3.3 Measurement Data

Mode:a

Harmonics – Class-A per Ed. 5.0 (2018)(Run time)

Test Result: Pass Source qualification: Normal

Current & voltage waveforms

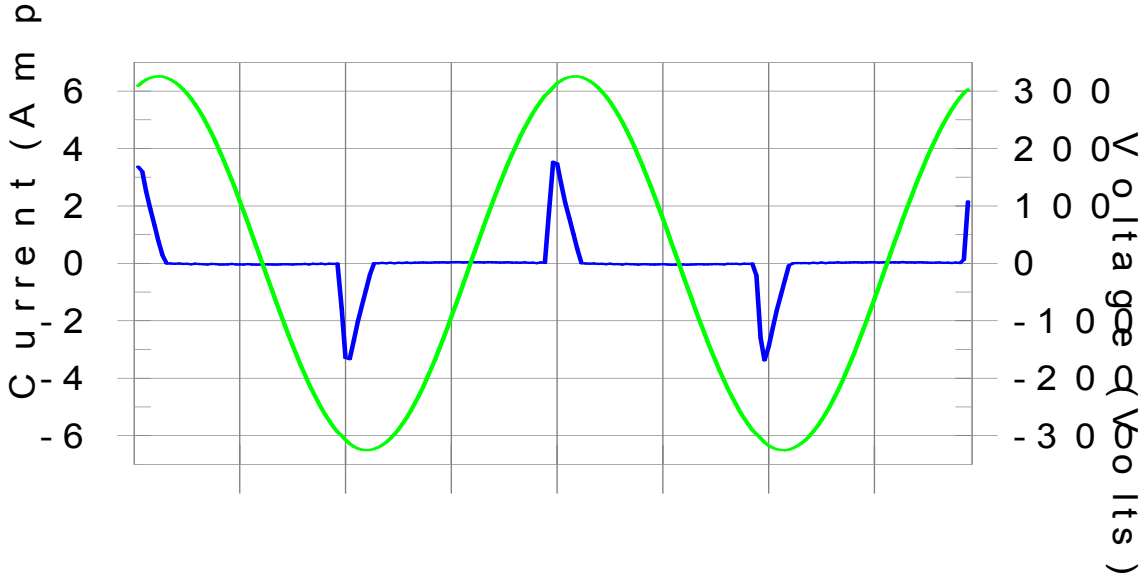

Harmonics and Class A limit line European Limits

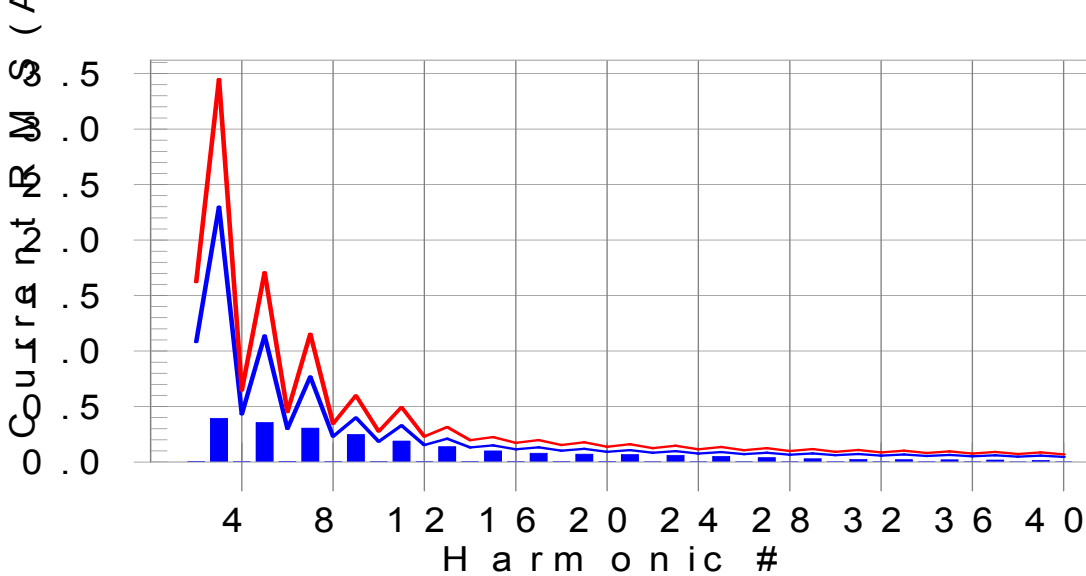

Test result: Pass Worst harmonics H15-46.6% of 150% limit, H15-66.7% of 100% limit



Unless otherwise agreed in writing, this document is issued by the Company subject to its General Conditions of Service printed overleaf, available on request or accessible at <http://www.sgs.com/en/Terms-and-Conditions.aspx> and, for electronic format documents, subject to Terms and Conditions for Electronic Documents at <http://www.sgs.com/en/Terms-and-Conditions/Terms-e-Document.aspx>. Attention is drawn to the limitation of liability, indemnification and jurisdiction issues defined therein. Any holder of this document is advised that information contained hereon reflects the Company's findings at the time of its intervention only and within the limits of Client's instructions, if any. The Company's sole responsibility is to its Client and this document does not exonerate parties to a transaction from exercising all their rights and obligations under the transaction documents. This document cannot be reproduced except in full, without prior written approval of the Company. Any unauthorized alteration, forgery or falsification of the content or appearance of this document is unlawful and offenders may be prosecuted to the fullest extent of the law. Unless otherwise stated the results shown in this test report refer only to the sample(s) tested and such sample(s) are retained for 30 days only.
Attention: To check the authenticity of testing /inspection report & certificate, please contact us at telephone: (86-755) 8307 1443, or email: CN.Doccheck@sgs.com

Current Test Result Summary (Run time)

Test Result: Pass **Source qualification: Normal**

THC(A): 0.728 I-THD(%): 172.8 POHC(A): 0.124 POHC Limit(A): 0.251

Highest parameter values during test:

V_RMS (Volts): 230.07	Frequency(Hz): 50.00
I_Peak (Amps): 3.685	I_RMS (Amps): 0.857
I_Fund (Amps): 0.421	Crest Factor: 4.340
Power (Watts): 93.3	Power Factor: 0.489

Harm#	Harms(avg)	100%Limit	%of Limit	Harms(max)	150%Limit	%of Limit	Status
2	0.003	1.080	N/A	0.005	1.620	N/A	Pass
3	0.395	2.300	17.2	0.397	3.450	11.5	Pass
4	0.003	0.430	N/A	0.005	0.645	N/A	Pass
5	0.357	1.140	31.3	0.359	1.710	21.0	Pass
6	0.003	0.300	N/A	0.006	0.450	N/A	Pass
7	0.306	0.770	39.8	0.309	1.155	26.8	Pass
8	0.003	0.230	N/A	0.006	0.345	N/A	Pass
9	0.248	0.400	62.0	0.251	0.600	41.9	Pass
10	0.003	0.184	N/A	0.006	0.276	N/A	Pass
11	0.190	0.330	57.5	0.194	0.495	39.2	Pass
12	0.003	0.153	N/A	0.005	0.230	N/A	Pass
13	0.138	0.210	65.9	0.143	0.315	45.4	Pass
14	0.003	0.131	N/A	0.004	0.197	N/A	Pass
15	0.100	0.150	66.7	0.105	0.225	46.6	Pass
16	0.003	0.115	N/A	0.004	0.173	N/A	Pass
17	0.079	0.132	59.9	0.084	0.198	42.2	Pass
18	0.002	0.102	N/A	0.004	0.153	N/A	Pass
19	0.071	0.118	60.3	0.075	0.178	42.4	Pass
20	0.002	0.092	N/A	0.003	0.138	N/A	Pass
21	0.068	0.107	63.0	0.071	0.161	44.1	Pass
22	0.002	0.084	N/A	0.003	0.125	N/A	Pass
23	0.061	0.098	62.5	0.064	0.147	43.8	Pass
24	0.002	0.077	N/A	0.003	0.115	N/A	Pass
25	0.051	0.090	56.8	0.054	0.135	40.2	Pass
26	0.002	0.071	N/A	0.003	0.107	N/A	Pass
27	0.039	0.083	47.4	0.042	0.125	33.9	Pass
28	0.002	0.066	N/A	0.002	0.099	N/A	Pass
29	0.029	0.078	37.7	0.032	0.116	27.1	Pass
30	0.001	0.061	N/A	0.002	0.092	N/A	Pass
31	0.023	0.073	32.0	0.025	0.109	22.6	Pass
32	0.001	0.058	N/A	0.002	0.086	N/A	Pass
33	0.021	0.068	31.2	0.022	0.102	21.5	Pass
34	0.001	0.054	N/A	0.002	0.081	N/A	Pass
35	0.020	0.064	31.8	0.021	0.096	21.7	Pass
36	0.001	0.051	N/A	0.002	0.077	N/A	Pass
37	0.018	0.061	30.3	0.019	0.091	20.9	Pass
38	0.001	0.048	N/A	0.002	0.073	N/A	Pass
39	0.015	0.058	25.8	0.016	0.087	18.2	Pass
40	0.001	0.046	N/A	0.002	0.069	N/A	Pass



Unless otherwise agreed in writing, this document is issued by the Company subject to its General Conditions of Service printed overleaf, available on request or accessible at <http://www.sgs.com/en/Terms-and-Conditions.aspx> and, for electronic format documents, subject to Terms and Conditions for Electronic Documents at <http://www.sgs.com/en/Terms-and-Conditions/Terms-e-Document.aspx>. Attention is drawn to the limitation of liability, indemnification and jurisdiction issues defined therein. Any holder of this document is advised that information contained hereon reflects the Company's findings at the time of its intervention only and within the limits of Client's instructions, if any. The Company's sole responsibility is to its Client and this document does not exonerate parties to a transaction from exercising all their rights and obligations under the transaction documents. This document cannot be reproduced except in full, without prior written approval of the Company. Any unauthorized alteration, forgery or falsification of the content or appearance of this document is unlawful and offenders may be prosecuted to the fullest extent of the law. Unless otherwise stated the results shown in this test report refer only to the sample(s) tested and such sample(s) are retained for 30 days only.

Attention: To check the authenticity of testing /inspection report & certificate, please contact us at telephone: (86-755) 8307 1443, or email: CN.Doccheck@sgs.com

6.4 Voltage Fluctuations and Flicker

Test Requirement: EN 61000-3-3:2013+A1:2019

Test Method: EN 61000-3-3:2013 +A1:2019

6.4.1 E.U.T. Operation

Operating Environment:

Temperature: 25.3 °C Humidity: 52 % RH Atmospheric Pressure: 1020 mbar

Pretest these modes to find the worst case:

- a: Test the EUT in Motor running mode with max output power & LED display,
- b: Test the EUT in Motor running mode with middle output power & LED display.
- C: Test the EUT in Motor running mode with lowest output power & LED display.

The worst case for final test:

- a: Test the EUT in Motor running mode with max output power & LED display,

6.4.2 Test Setup Diagram

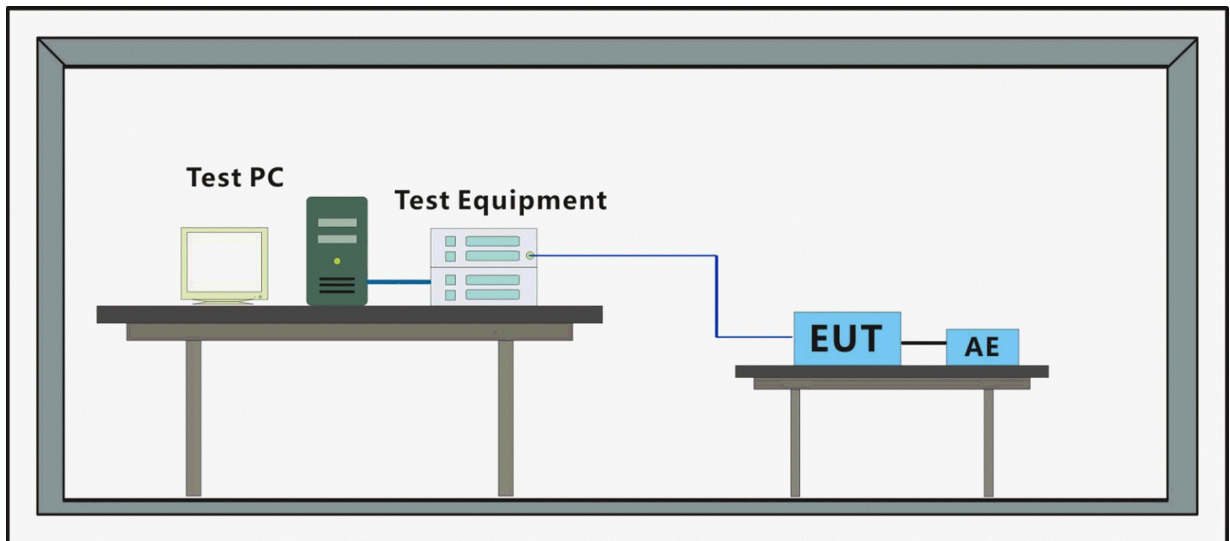

Unless otherwise agreed in writing, this document is issued by the Company subject to its General Conditions of Service printed overleaf, available on request or accessible at <http://www.sgs.com/en/Terms-and-Conditions.aspx> and, for electronic format documents, subject to Terms and Conditions for Electronic Documents at <http://www.sgs.com/en/Terms-and-Conditions/Terms-e-Document.aspx>. Attention is drawn to the limitation of liability, indemnification and jurisdiction issues defined therein. Any holder of this document is advised that information contained hereon reflects the Company's findings at the time of its intervention only and within the limits of Client's instructions, if any. The Company's sole responsibility is to its Client and this document does not exonerate parties to a transaction from exercising all their rights and obligations under the transaction documents. This document cannot be reproduced except in full, without prior written approval of the Company. Any unauthorized alteration, forgery or falsification of the content or appearance of this document is unlawful and offenders may be prosecuted to the fullest extent of the law. Unless otherwise stated the results shown in this test report refer only to the sample(s) tested and such sample(s) are retained for 30 days only.

Attention: To check the authenticity of testing /inspection report & certificate, please contact us at telephone: (86-755) 8307 1443, or email: CN.Doccheck@sgs.com

6.4.3 Measurement Data

Mode:a

Flicker Test Summary per EN 61000-3-3 (Run time)

Test Result: Pass

Status: Test Completed

Pst_i and limit line

European Limits

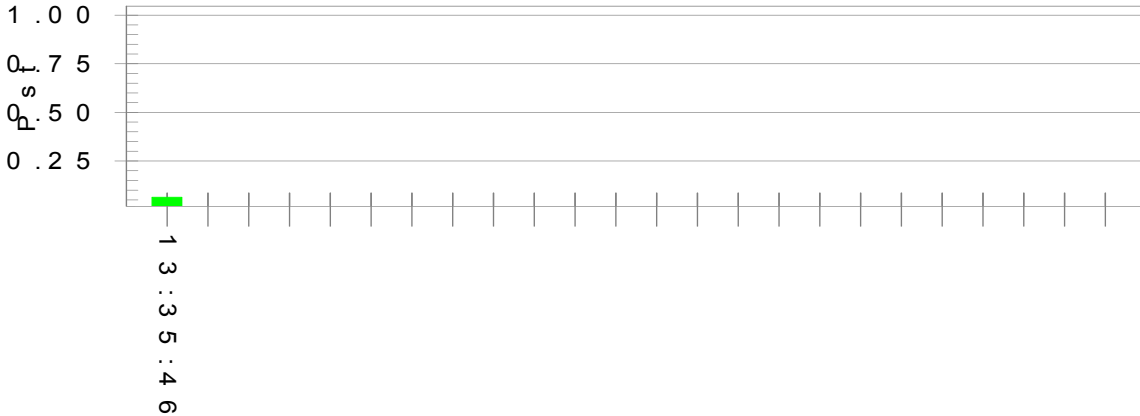

Parameter values recorded during the test:

Vrms at the end of test (Volt):	230.10		
T-max (mS):	0	Test limit (mS):	500.0 Pass
Highest dc (%):	0.00	Test limit (%):	3.30 Pass
Highest dmax (%):	0.00	Test limit (%):	4.00 Pass
Highest Pst (10 min. period):	0.064	Test limit:	1.000 Pass



Unless otherwise agreed in writing, this document is issued by the Company subject to its General Conditions of Service printed overleaf, available on request or accessible at <http://www.sgs.com/en/Terms-and-Conditions.aspx> and, for electronic format documents, subject to Terms and Conditions for Electronic Documents at <http://www.sgs.com/en/Terms-and-Conditions/Terms-e-Document.aspx>. Attention is drawn to the limitation of liability, indemnification and jurisdiction issues defined therein. Any holder of this document is advised that information contained hereon reflects the Company's findings at the time of its intervention only and within the limits of Client's instructions, if any. The Company's sole responsibility is to its Client and this document does not exonerate parties to a transaction from exercising all their rights and obligations under the transaction documents. This document cannot be reproduced except in full, without prior written approval of the Company. Any unauthorized alteration, forgery or falsification of the content or appearance of this document is unlawful and offenders may be prosecuted to the fullest extent of the law. Unless otherwise stated the results shown in this test report refer only to the sample(s) tested and such sample(s) are retained for 30 days only.

Attention: To check the authenticity of testing /inspection report & certificate, please contact us at telephone: (86-755) 8307 1443, or email: CN.Doccheck@sgs.com

7 Immunity Test Results

7.1 Performance Criteria Description in EN 55014-2:2015

- Criterion A** The apparatus shall continue to operate as intended during the test. No degradation of performance or loss of function is allowed below a performance level (or permissible loss of performance) specified by the manufacturer, when the apparatus is used as intended. If the minimum performance level or the permissible performance loss is not specified by the manufacturer, then either of these may be derived from the product description and documentation, and from what the user may reasonably expect from the apparatus if used as intended.
- Criterion B** The apparatus shall continue to operate as intended after the test. No degradation of performance or loss of function is allowed below a performance level (or permissible loss of performance) specified by the manufacturer, when the apparatus is used as intended. During the test, degradation of performance is allowed, however. No change of actual operating state or stored data is allowed. If the minimum performance level or the permissible performance loss is not specified by the manufacturer, then either of these may be derived from the product description and documentation and from what the user may reasonably expect from the apparatus if used as intended.
- Criterion C** Temporary loss of function is allowed, provided the function is self recoverable or can be restored by the operation of the controls, or by any operation specified in the instructions for use.



Unless otherwise agreed in writing, this document is issued by the Company subject to its General Conditions of Service printed overleaf, available on request or accessible at <http://www.sgs.com/en/Terms-and-Conditions.aspx> and, for electronic format documents, subject to Terms and Conditions for Electronic Documents at <http://www.sgs.com/en/Terms-and-Conditions/Terms-e-Document.aspx>. Attention is drawn to the limitation of liability, indemnification and jurisdiction issues defined therein. Any holder of this document is advised that information contained hereon reflects the Company's findings at the time of its intervention only and within the limits of Client's instructions, if any. The Company's sole responsibility is to its Client and this document does not exonerate parties to a transaction from exercising all their rights and obligations under the transaction documents. This document cannot be reproduced except in full, without prior written approval of the Company. Any unauthorized alteration, forgery or falsification of the content or appearance of this document is unlawful and offenders may be prosecuted to the fullest extent of the law. Unless otherwise stated the results shown in this test report refer only to the sample(s) tested and such sample(s) are retained for 30 days only.

Attention: To check the authenticity of testing /inspection report & certificate, please contact us at telephone: (86-755) 8307 1443, or email: CN.Doccheck@sgs.com

7.2 Electrostatic Discharge

Test Requirement:	EN 55014-2:2015
Test Method:	EN 61000-4-2:2009
Performance Criterion:	B
Discharge Impedance:	330Ω/150pF
Number of Discharge:	Minimum 10 times at each test point
Discharge Mode:	Single Discharge
Discharge Period:	1 second minimum

7.2.1 E.U.T. Operation

Operating Environment:

Temperature: 25.3 °C Humidity: 52 % RH Atmospheric Pressure: 1020 mbar

- Test Mode:
- a: Test the EUT in Motor running mode with max output power & LED display,
 - b: Test the EUT in Motor running mode with middle output power & LED display.
 - C: Test the EUT in Motor running mode with lowest output power & LED display.
 - D: Test the EUT in standby mode.
 - E: Test the EUT in continuously transmitting mode.

7.2.2 Test Setup Diagram

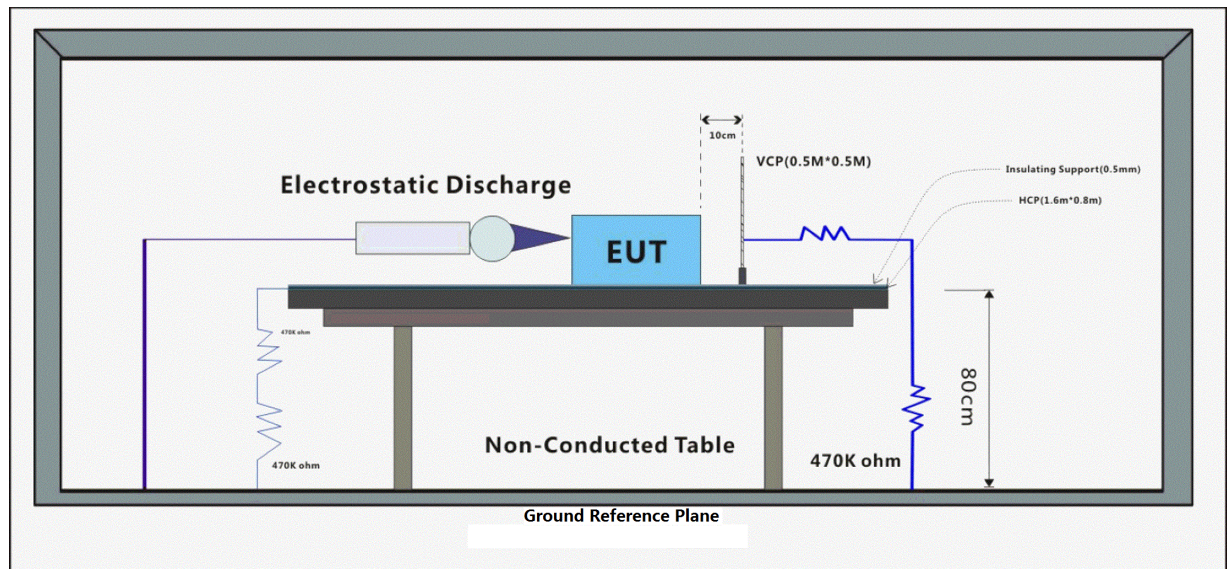

Unless otherwise agreed in writing, this document is issued by the Company subject to its General Conditions of Service printed overleaf, available on request or accessible at <http://www.sgs.com/en/Terms-and-Conditions.aspx> and, for electronic format documents, subject to Terms and Conditions for Electronic Documents at <http://www.sgs.com/en/Terms-and-Conditions/Terms-e-Documents.aspx>. Attention is drawn to the limitation of liability, indemnification and jurisdiction issues defined therein. Any holder of this document is advised that information contained hereon reflects the Company's findings at the time of its intervention only and within the limits of Client's instructions, if any. The Company's sole responsibility is to its Client and this document does not exonerate parties to a transaction from exercising all their rights and obligations under the transaction documents. This document cannot be reproduced except in full, without prior written approval of the Company. Any unauthorized alteration, forgery or falsification of the content or appearance of this document is unlawful and offenders may be prosecuted to the fullest extent of the law. Unless otherwise stated the results shown in this test report refer only to the sample(s) tested and such sample(s) are retained for 30 days only.

Attention: To check the authenticity of testing / inspection report & certificate, please contact us at telephone: (86-755) 8307 1443, or email: CN.Doccheck@sgs.com

7.2.3 Test Results

Test Point:

Observations:

1. All insulated enclosure and seams.
2. All accessible metal parts of the enclosure.
3. All side

Discharge type	Level (kV)	Polarity	Test Point	Result / Observations
Air Discharge	8	+	1	A
Air Discharge	8	-	1	A
Contact Discharge	4	+	2	A
Contact Discharge	4	-	2	A
Horizontal Coupling	4	+	3	N/A
Horizontal Coupling	4	-	3	N/A
Vertical Coupling	4	+	3	A
Vertical Coupling	4	-	3	A

Results:

A: No degradation in the performance of the EUT was observed.

N/A: not applicable.



Unless otherwise agreed in writing, this document is issued by the Company subject to its General Conditions of Service printed overleaf, available on request or accessible at <http://www.sgs.com/en/Terms-and-Conditions.aspx> and, for electronic format documents, subject to Terms and Conditions for Electronic Documents at <http://www.sgs.com/en/Terms-and-Conditions/Terms-e-Document.aspx>. Attention is drawn to the limitation of liability, indemnification and jurisdiction issues defined therein. Any holder of this document is advised that information contained hereon reflects the Company's findings at the time of its intervention only and within the limits of Client's instructions, if any. The Company's sole responsibility is to its Client and this document does not exonerate parties to a transaction from exercising all their rights and obligations under the transaction documents. This document cannot be reproduced except in full, without prior written approval of the Company. Any unauthorized alteration, forgery or falsification of the content or appearance of this document is unlawful and offenders may be prosecuted to the fullest extent of the law. Unless otherwise stated the results shown in this test report refer only to the sample(s) tested and such sample(s) are retained for 30 days only.
Attention: To check the authenticity of testing /inspection report & certificate, please contact us at telephone: (86-755) 8307 1443, or email: CN.Doccheck@sgs.com

7.3 Radiated Immunity (80MHz-1GHz)

Test Requirement: EN 55014-2:2015
 Test Method: EN 61000-4-3:2006 +A1:2008+A2:2010
 Performance Criterion: A
 Frequency Range: 80MHz to 1GHz
 Antenna Polarisation: Vertical and Horizontal
 Modulation: 1kHz,80% Amp. Mod,1% increment

7.3.1 E.U.T. Operation

Operating Environment:
 Temperature: 23 °C Humidity: 52 % RH Atmospheric Pressure: 1020 mbar
 Test Mode:
 d: Test the EUT in standby mode.
 e: Test the EUT in continuously transmitting mode.

7.3.2 Test Setup Diagram

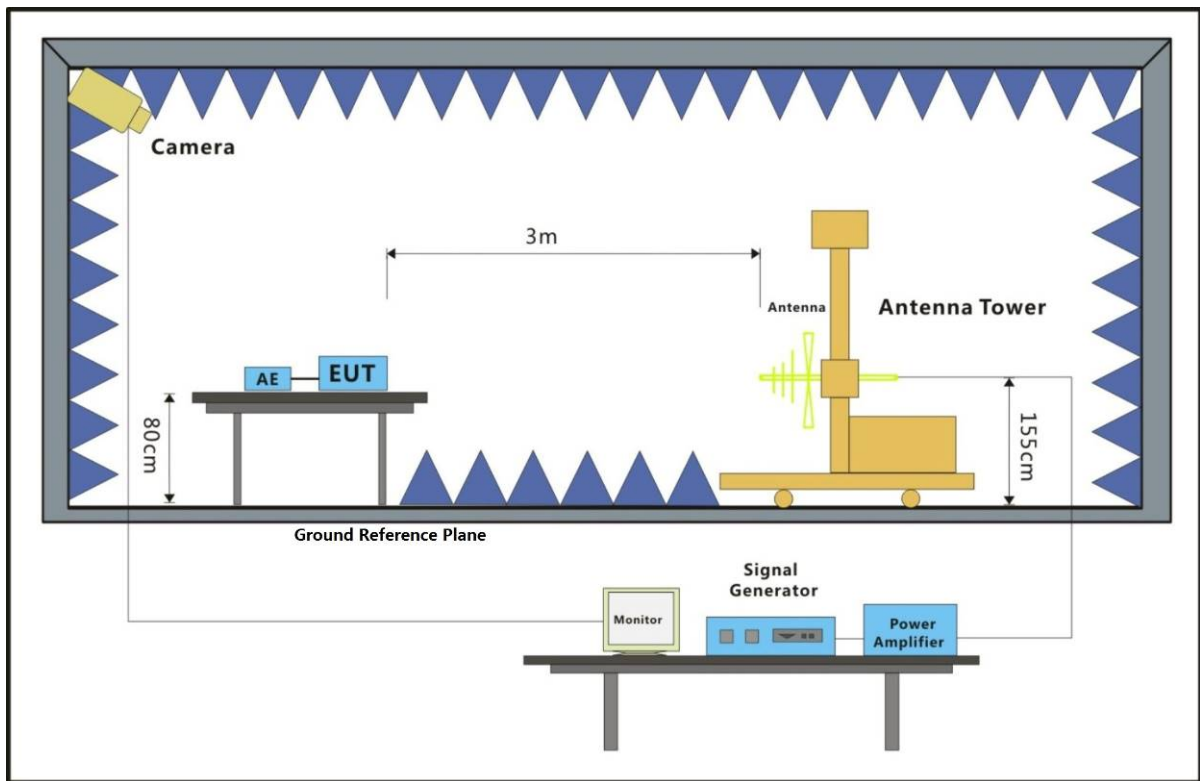

Unless otherwise agreed in writing, this document is issued by the Company subject to its General Conditions of Service printed overleaf, available on request or accessible at <http://www.sgs.com/en/Terms-and-Conditions.aspx> and, for electronic format documents, subject to Terms and Conditions for Electronic Documents at <http://www.sgs.com/en/Terms-and-Conditions/Terms-e-Document.aspx>. Attention is drawn to the limitation of liability, indemnification and jurisdiction issues defined therein. Any holder of this document is advised that information contained hereon reflects the Company's findings at the time of its intervention only and within the limits of Client's instructions, if any. The Company's sole responsibility is to its Client and this document does not exonerate parties to a transaction from exercising all their rights and obligations under the transaction documents. This document cannot be reproduced except in full, without prior written approval of the Company. Any unauthorized alteration, forgery or falsification of the content or appearance of this document is unlawful and offenders may be prosecuted to the fullest extent of the law. Unless otherwise stated the results shown in this test report refer only to the sample(s) tested and such sample(s) are retained for 30 days only.
Attention: To check the authenticity of testing /inspection report & certificate, please contact us at telephone: (86-755) 8307 1443, or email: CN.Doccheck@sgs.com

7.3.3 Test Results

Frequency	Level (V/m)	EUT Face	Dwell time	Result / Observations
80MHz-1GHz	3	Front	2s	A
80MHz-1GHz	3	Back	2s	A
80MHz-1GHz	3	Left	2s	A
80MHz-1GHz	3	Right	2s	A
80MHz-1GHz	3	Top	2s	A
80MHz-1GHz	3	Underside	2s	A

Results:

A: No degradation in the performance of the EUT was observed.



Unless otherwise agreed in writing, this document is issued by the Company subject to its General Conditions of Service printed overleaf, available on request or accessible at <http://www.sgs.com/en/Terms-and-Conditions.aspx> and, for electronic format documents, subject to Terms and Conditions for Electronic Documents at <http://www.sgs.com/en/Terms-and-Conditions/Terms-e-Document.aspx>. Attention is drawn to the limitation of liability, indemnification and jurisdiction issues defined therein. Any holder of this document is advised that information contained hereon reflects the Company's findings at the time of its intervention only and within the limits of Client's instructions, if any. The Company's sole responsibility is to its Client and this document does not exonerate parties to a transaction from exercising all their rights and obligations under the transaction documents. This document cannot be reproduced except in full, without prior written approval of the Company. Any unauthorized alteration, forgery or falsification of the content or appearance of this document is unlawful and offenders may be prosecuted to the fullest extent of the law. Unless otherwise stated the results shown in this test report refer only to the sample(s) tested and such sample(s) are retained for 30 days only.
Attention: To check the authenticity of testing /inspection report & certificate, please contact us at telephone: (86-755) 8307 1443, or email: CN.Doccheck@sgs.com

7.4 Electrical Fast Transients/Burst at Power Port

Test Requirement: EN 55014-2:2015
 Test Method: EN 61000-4-4:2012
 Performance Criterion: B
 Repetition Frequency: 5kHz
 Burst Period: 300ms
 Test Duration: 2 minute per level & polarity

7.4.1 E.U.T. Operation

Operating Environment:
 Temperature: 25.5 °C Humidity: 66.5 % RH Atmospheric Pressure: 1020 mbar
 Test Mode:
 a: Test the EUT in Motor running mode with max output power & LED display,
 b: Test the EUT in Motor running mode with middle output power & LED display.
 c: Test the EUT in Motor running mode with lowest output power & LED display.
 d: Test the EUT in standby mode.

7.4.2 Test Setup Diagram

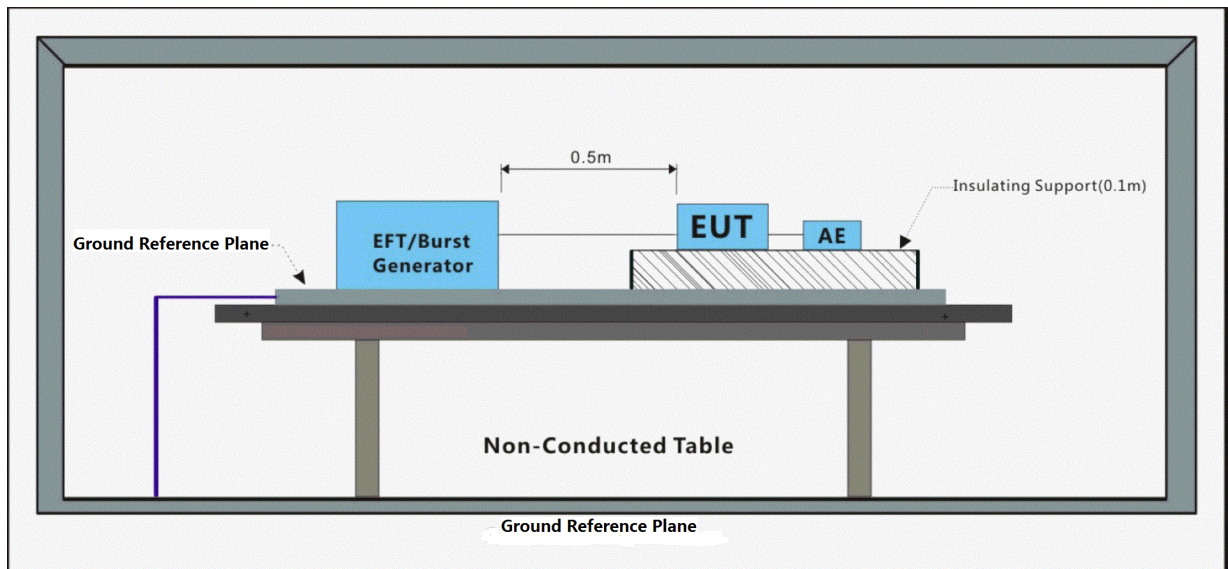

7.4.3 Test Results

Test Line	Level (kV)	Polarity	CDN/Clamp	Result / Observations
AC power port	1	+	CDN	A
AC power port	1	-	CDN	A

Results:

A: No degradation in the performance of the EUT was observed.



Unless otherwise agreed in writing, this document is issued by the Company subject to its General Conditions of Service printed overleaf, available on request or accessible at <http://www.sgs.com/en/Terms-and-Conditions.aspx> and, for electronic format documents, subject to Terms and Conditions for Electronic Documents at <http://www.sgs.com/en/Terms-and-Conditions/Terms-e-Document.aspx>. Attention is drawn to the limitation of liability, indemnification and jurisdiction issues defined therein. Any holder of this document is advised that information contained hereon reflects the Company's findings at the time of its intervention only and within the limits of Client's instructions, if any. The Company's sole responsibility is to its Client and this document does not exonerate parties to a transaction from exercising all their rights and obligations under the transaction documents. This document cannot be reproduced except in full, without prior written approval of the Company. Any unauthorized alteration, forgery or falsification of the content or appearance of this document is unlawful and offenders may be prosecuted to the fullest extent of the law. Unless otherwise stated the results shown in this test report refer only to the sample(s) tested and such sample(s) are retained for 30 days only.
 Attention: To check the authenticity of testing / inspection report & certificate, please contact us at telephone: (86-755) 8307 1443, or email: CN.Doccheck@sgs.com

7.5 Surge at Power Port

Test Requirement: EN 55014-2:2015
 Test Method: EN 61000-4-5:2014
 Performance Criterion: B
 Interval: 60s between each surge
 No. of surges: 5 positive at 90°, 5 negative at 270°.

7.5.1 E.U.T. Operation

Operating Environment:
 Temperature: 25.5 °C Humidity: 66.5 % RH Atmospheric Pressure: 1020 mbar
 Test Mode:
 a: Test the EUT in Motor running mode with max output power & LED display,
 b: Test the EUT in Motor running mode with middle output power & LED display.
 c: Test the EUT in Motor running mode with lowest output power & LED display.
 d: Test the EUT in standby mode.

7.5.2 Test Setup Diagram

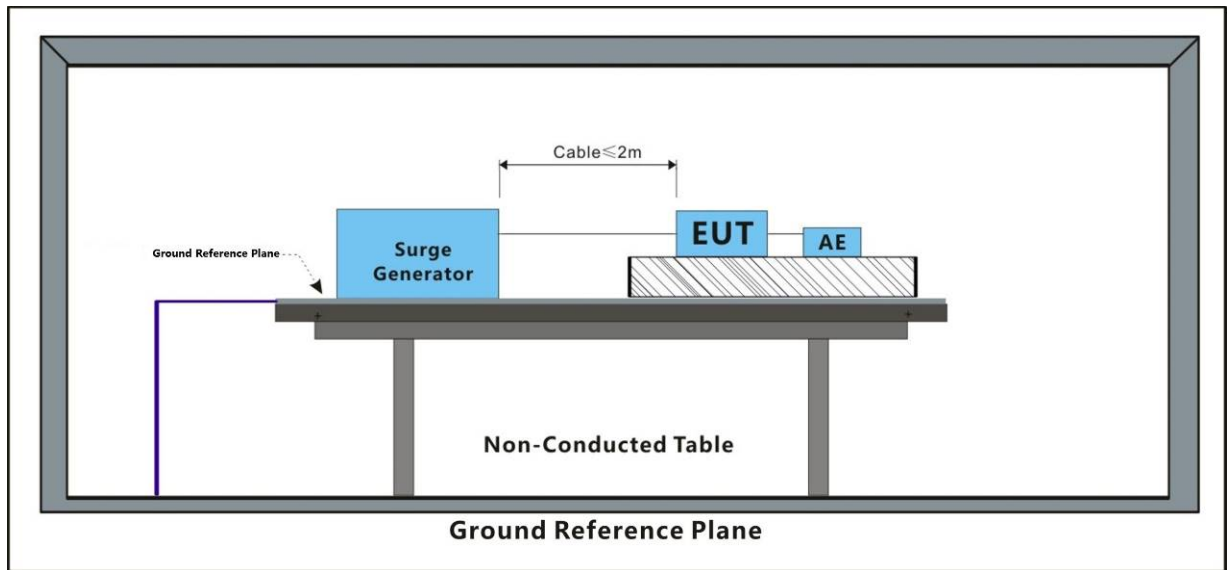

7.5.3 Test Results

Test Line	Level (kV)	Polarity	Phase (deg)	Result / Observations
L-N	1	+	90°	A
L-N	1	-	270°	A
L-PE	2	+	90°	A
L-PE	2	-	270°	A
N-PE	2	+	90°	A
N-PE	2	-	270°	A

Results:

A: No degradation in the performance of the EUT was observed.



Unless otherwise agreed in writing, this document is issued by the Company subject to its General Conditions of Service printed overleaf, available on request or accessible at <http://www.sgs.com/en/Terms-and-Conditions.aspx> and, for electronic format documents, subject to Terms and Conditions for Electronic Documents at <http://www.sgs.com/en/Terms-and-Conditions/Terms-e-Documents.aspx>. Attention is drawn to the limitation of liability, indemnification and jurisdiction issues defined therein. Any holder of this document is advised that information contained hereon reflects the Company's findings at the time of its intervention only and within the limits of Client's instructions, if any. The Company's sole responsibility is to its Client and this document does not exonerate parties to a transaction from exercising all their rights and obligations under the transaction documents. This document cannot be reproduced except in full, without prior written approval of the Company. Any unauthorized alteration, forgery or falsification of the content or appearance of this document is unlawful and offenders may be prosecuted to the fullest extent of the law. Unless otherwise stated the results shown in this test report refer only to the sample(s) tested and such sample(s) are retained for 30 days only.
Attention: To check the authenticity of testing / inspection report & certificate, please contact us at telephone: (86-755) 8307 1443, or email: CN.Doccheck@sgs.com

7.6 Voltage Dips and Interruptions

Test Requirement: EN 55014-2:2015
 Test Method: EN 61000-4-11:2004
 Performance Criterion: For 50Hz:
 0% of UT (Rated Voltage) for 0.5 Cycle: C;
 40% of UT for 10 Cycle: C;
 70% of UT for 25 Cycle: C
 For 60Hz:
 0% of UT (Rated Voltage) for 0.5 Cycle: C;
 40% of UT for 12 Cycle: C;
 70% of UT for 30 Cycle: C
 No. of Dips / Interruptions: 3 per Level
 Time between dropout 10s

7.6.1 E.U.T. Operation

Operating Environment:
 Temperature: 25.5 °C Humidity: 66.5 % RH Atmospheric Pressure: 1020 mbar
 Test Mode:
 a: Test the EUT in Motor running mode with max output power & LED display,
 b: Test the EUT in Motor running mode with middle output power & LED display.
 c: Test the EUT in Motor running mode with lowest output power & LED display.
 d: Test the EUT in standby mode.

7.6.2 Test Setup Diagram

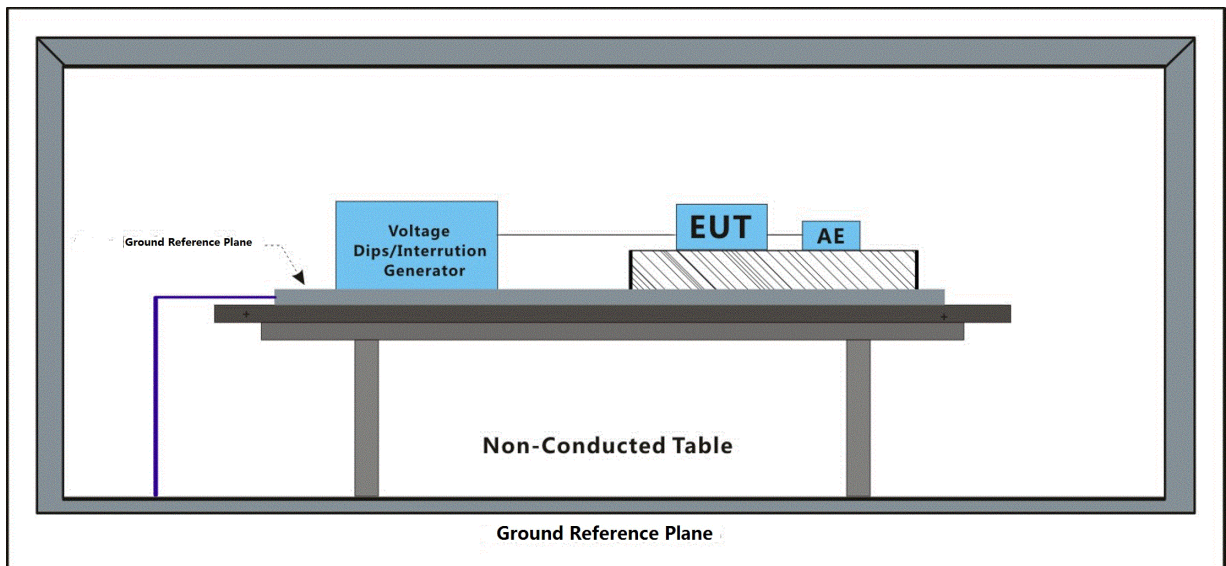

Unless otherwise agreed in writing, this document is issued by the Company subject to its General Conditions of Service printed overleaf, available on request or accessible at <http://www.sgs.com/en/Terms-and-Conditions.aspx> and, for electronic format documents, subject to Terms and Conditions for Electronic Documents at <http://www.sgs.com/en/Terms-and-Conditions/Terms-e-Document.aspx>. Attention is drawn to the limitation of liability, indemnification and jurisdiction issues defined therein. Any holder of this document is advised that information contained hereon reflects the Company's findings at the time of its intervention only and within the limits of Client's instructions, if any. The Company's sole responsibility is to its Client and this document does not exonerate parties to a transaction from exercising all their rights and obligations under the transaction documents. This document cannot be reproduced except in full, without prior written approval of the Company. Any unauthorized alteration, forgery or falsification of the content or appearance of this document is unlawful and offenders may be prosecuted to the fullest extent of the law. Unless otherwise stated the results shown in this test report refer only to the sample(s) tested and such sample(s) are retained for 30 days only.
Attention: To check the authenticity of testing / inspection report & certificate, please contact us at telephone: (86-755) 8307 1443, or email: CN.Doccheck@sgs.com

7.6.3 Test Results

Level % UT	Phase (deg)	Duration	No. of Dips / Interruptions	Result / Observations
0	0°	0.5 Cycles for 50Hz	3	A
0	180°	0.5 Cycles for 50Hz	3	A
40	0°	10 Cycles for 50Hz	3	A
40	180°	10 Cycles for 50Hz	3	A
70	0°	25 Cycles for 50Hz	3	A
70	180°	25 Cycles for 50Hz	3	A
0	0°	0.5 Cycles for 60Hz	3	A
0	180°	0.5 Cycles for 60Hz	3	A
40	0°	12 Cycles for 60Hz	3	A
40	180°	12 Cycles for 60Hz	3	A
70	0°	30 Cycles for 60Hz	3	A
70	180°	30 Cycles for 60Hz	3	A

Results:

A: No degradation in the performance of the EUT was observed.



Unless otherwise agreed in writing, this document is issued by the Company subject to its General Conditions of Service printed overleaf, available on request or accessible at <http://www.sgs.com/en/Terms-and-Conditions.aspx> and, for electronic format documents, subject to Terms and Conditions for Electronic Documents at <http://www.sgs.com/en/Terms-and-Conditions/Terms-e-Documents.aspx>. Attention is drawn to the limitation of liability, indemnification and jurisdiction issues defined therein. Any holder of this document is advised that information contained hereon reflects the Company's findings at the time of its intervention only and within the limits of Client's instructions, if any. The Company's sole responsibility is to its Client and this document does not exonerate parties to a transaction from exercising all their rights and obligations under the transaction documents. This document cannot be reproduced except in full, without prior written approval of the Company. Any unauthorized alteration, forgery or falsification of the content or appearance of this document is unlawful and offenders may be prosecuted to the fullest extent of the law. Unless otherwise stated the results shown in this test report refer only to the sample(s) tested and such sample(s) are retained for 30 days only.

Attention: To check the authenticity of testing / inspection report & certificate, please contact us at telephone: (86-755) 8307 1443, or email: CN.Doccheck@sgs.com

7.7 Conducted Immunity at Power Port (150kHz-230MHz)

Test Requirement: EN 55014-2:2015
 Test Method: EN 61000-4-6:2014
 Performance Criterion: A
 Frequency Range: 0.15MHz to 230MHz
 Modulation: 80%, 1kHz Amplitude Modulation
 Step Size 1%

7.7.1 E.U.T. Operation

Operating Environment:

Temperature: 25.5 °C Humidity: 66.5 % RH Atmospheric Pressure: 1020 mbar

Test Mode:
 a: Test the EUT in Motor running mode with max output power & LED display,
 b: Test the EUT in Motor running mode with middle output power & LED display.
 c: Test the EUT in Motor running mode with lowest output power & LED display.
 d: Test the EUT in standby mode.

7.7.2 Test Setup Diagram

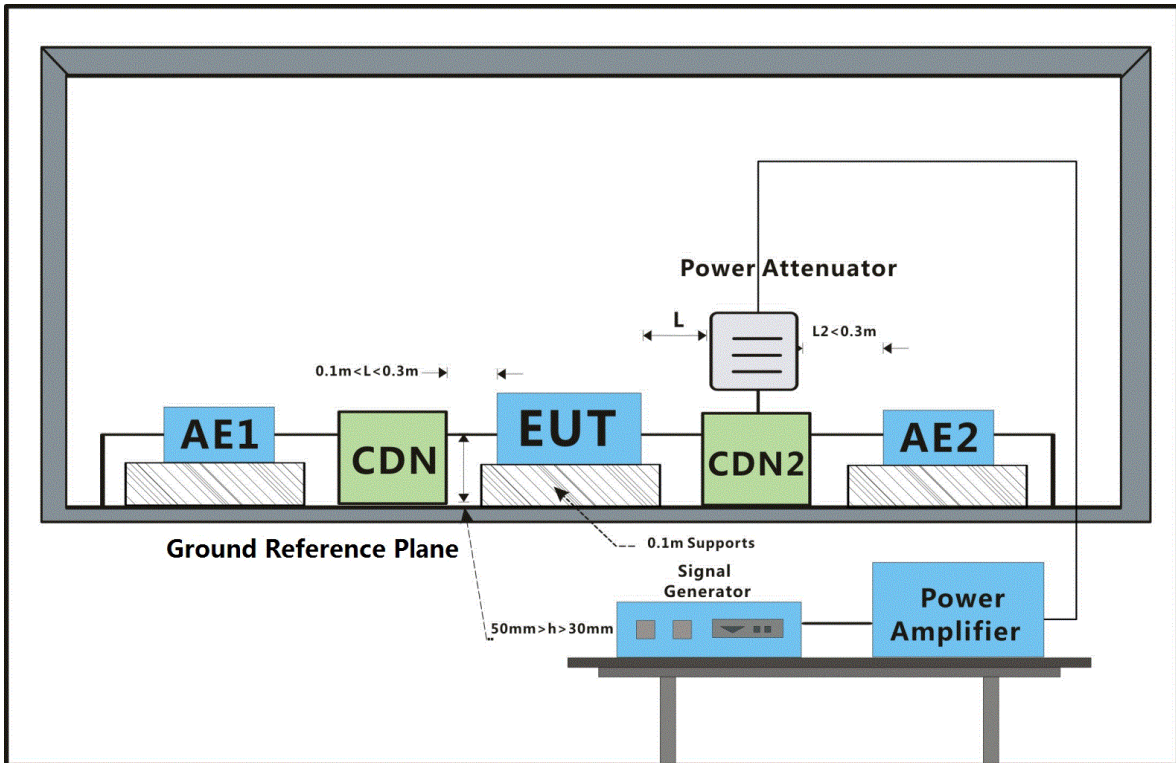

7.7.3 Test Results

Cable port	Level (Vrms)	CDN/Clamp	Dwell time	Result / Observations
AC power port	3	CDN	2s	A

Results:

A: No degradation in the performance of the EUT was observed.



Unless otherwise agreed in writing, this document is issued by the Company subject to its General Conditions of Service printed overleaf, available on request or accessible at <http://www.sgs.com/en/Terms-and-Conditions.aspx> and, for electronic format documents, subject to Terms and Conditions for Electronic Documents at <http://www.sgs.com/en/Terms-and-Conditions/Terms-e-Document.aspx>. Attention is drawn to the limitation of liability, indemnification and jurisdiction issues defined therein. Any holder of this document is advised that information contained hereon reflects the Company's findings at the time of its intervention only and within the limits of Client's instructions, if any. The Company's sole responsibility is to its Client and this document does not exonerate parties to a transaction from exercising all their rights and obligations under the transaction documents. This document cannot be reproduced except in full, without prior written approval of the Company. Any unauthorized alteration, forgery or falsification of the content or appearance of this document is unlawful and offenders may be prosecuted to the fullest extent of the law. Unless otherwise stated the results shown in this test report refer only to the sample(s) tested and such sample(s) are retained for 30 days only.
Attention: To check the authenticity of testing /inspection report & certificate, please contact us at telephone: (86-755) 8307 1443, or email: CN.Doccheck@sgs.com

8 Photographs

8.1 Conducted Emissions at Mains Terminals (150kHz-30MHz) Test Setup

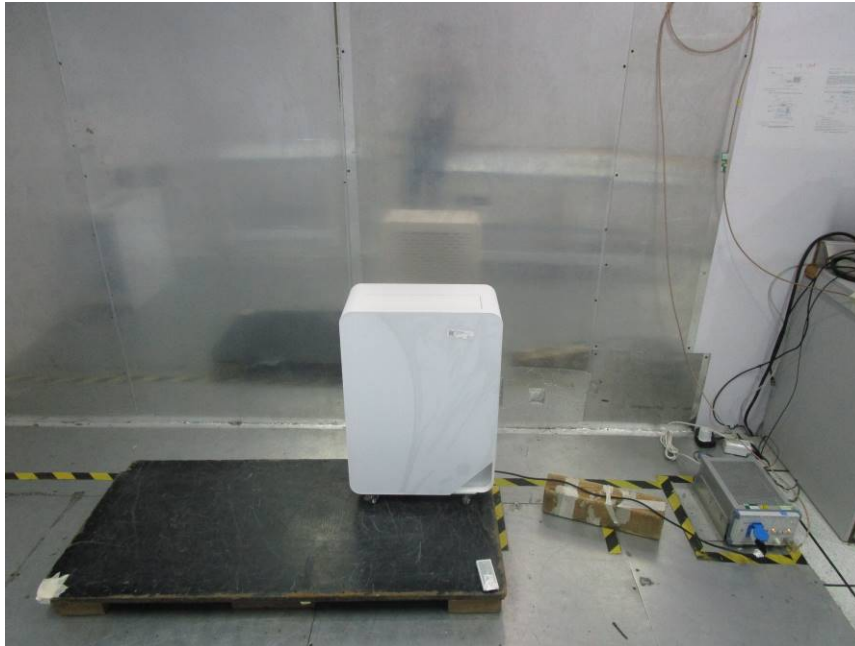

8.2 Radiated Emissions (30MHz-1GHz) Test Setup

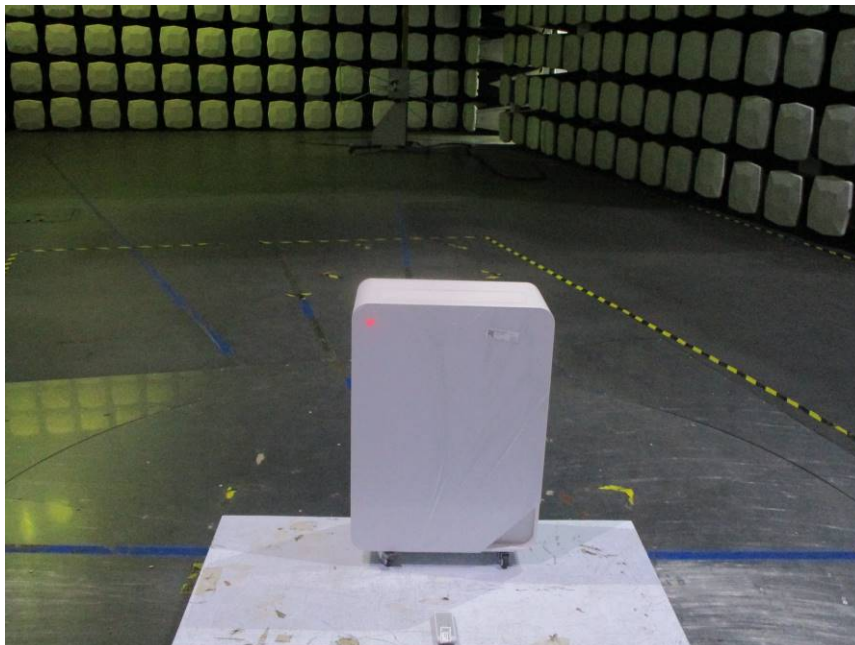

Unless otherwise agreed in writing, this document is issued by the Company subject to its General Conditions of Service printed overleaf, available on request or accessible at <http://www.sgs.com/en/Terms-and-Conditions.aspx> and, for electronic format documents, subject to Terms and Conditions for Electronic Documents at <http://www.sgs.com/en/Terms-and-Conditions/Terms-e-Document.aspx>. Attention is drawn to the limitation of liability, indemnification and jurisdiction issues defined therein. Any holder of this document is advised that information contained hereon reflects the Company's findings at the time of its intervention only and within the limits of Client's instructions, if any. The Company's sole responsibility is to its Client and this document does not exonerate parties to a transaction from exercising all their rights and obligations under the transaction documents. This document cannot be reproduced except in full, without prior written approval of the Company. Any unauthorized alteration, forgery or falsification of the content or appearance of this document is unlawful and offenders may be prosecuted to the fullest extent of the law. Unless otherwise stated the results shown in this test report refer only to the sample(s) tested and such sample(s) are retained for 30 days only.

Attention: To check the authenticity of testing /inspection report & certificate, please contact us at telephone: (86-755) 8307 1443, or email: CN.Doccheck@sgs.com

8.3 Harmonic Current Emission Test Setup



Unless otherwise agreed in writing, this document is issued by the Company subject to its General Conditions of Service printed overleaf, available on request or accessible at <http://www.sgs.com/en/Terms-and-Conditions.aspx> and, for electronic format documents, subject to Terms and Conditions for Electronic Documents at <http://www.sgs.com/en/Terms-and-Conditions/Terms-e-Document.aspx>. Attention is drawn to the limitation of liability, indemnification and jurisdiction issues defined therein. Any holder of this document is advised that information contained hereon reflects the Company's findings at the time of its intervention only and within the limits of Client's instructions, if any. The Company's sole responsibility is to its Client and this document does not exonerate parties to a transaction from exercising all their rights and obligations under the transaction documents. This document cannot be reproduced except in full, without prior written approval of the Company. Any unauthorized alteration, forgery or falsification of the content or appearance of this document is unlawful and offenders may be prosecuted to the fullest extent of the law. Unless otherwise stated the results shown in this test report refer only to the sample(s) tested and such sample(s) are retained for 30 days only.

Attention: To check the authenticity of testing /inspection report & certificate, please contact us at telephone: (86-755) 8307 1443, or email: CN.Doccheck@sgs.com

8.4 Voltage Fluctuations and Flicker Test Setup



Unless otherwise agreed in writing, this document is issued by the Company subject to its General Conditions of Service printed overleaf, available on request or accessible at <http://www.sgs.com/en/Terms-and-Conditions.aspx> and, for electronic format documents, subject to Terms and Conditions for Electronic Documents at <http://www.sgs.com/en/Terms-and-Conditions/Terms-e-Document.aspx>. Attention is drawn to the limitation of liability, indemnification and jurisdiction issues defined therein. Any holder of this document is advised that information contained hereon reflects the Company's findings at the time of its intervention only and within the limits of Client's instructions, if any. The Company's sole responsibility is to its Client and this document does not exonerate parties to a transaction from exercising all their rights and obligations under the transaction documents. This document cannot be reproduced except in full, without prior written approval of the Company. Any unauthorized alteration, forgery or falsification of the content or appearance of this document is unlawful and offenders may be prosecuted to the fullest extent of the law. Unless otherwise stated the results shown in this test report refer only to the sample(s) tested and such sample(s) are retained for 30 days only.

Attention: To check the authenticity of testing /inspection report & certificate, please contact us at telephone: (86-755) 8307 1443, or email: CN.Doccheck@sgs.com

8.5 Electrostatic Discharge Test Setup



Unless otherwise agreed in writing, this document is issued by the Company subject to its General Conditions of Service printed overleaf, available on request or accessible at <http://www.sgs.com/en/Terms-and-Conditions.aspx> and, for electronic format documents, subject to Terms and Conditions for Electronic Documents at <http://www.sgs.com/en/Terms-and-Conditions/Terms-e-Document.aspx>. Attention is drawn to the limitation of liability, indemnification and jurisdiction issues defined therein. Any holder of this document is advised that information contained hereon reflects the Company's findings at the time of its intervention only and within the limits of Client's instructions, if any. The Company's sole responsibility is to its Client and this document does not exonerate parties to a transaction from exercising all their rights and obligations under the transaction documents. This document cannot be reproduced except in full, without prior written approval of the Company. Any unauthorized alteration, forgery or falsification of the content or appearance of this document is unlawful and offenders may be prosecuted to the fullest extent of the law. Unless otherwise stated the results shown in this test report refer only to the sample(s) tested and such sample(s) are retained for 30 days only.

Attention: To check the authenticity of testing /inspection report & certificate, please contact us at telephone: (86-755) 8307 1443, or email: CN.Doccheck@sgs.com

8.6 Radiated Immunity (80MHz-1GHz) Test Setup



Unless otherwise agreed in writing, this document is issued by the Company subject to its General Conditions of Service printed overleaf, available on request or accessible at <http://www.sgs.com/en/Terms-and-Conditions.aspx> and, for electronic format documents, subject to Terms and Conditions for Electronic Documents at <http://www.sgs.com/en/Terms-and-Conditions/Terms-e-Documents.aspx>. Attention is drawn to the limitation of liability, indemnification and jurisdiction issues defined therein. Any holder of this document is advised that information contained hereon reflects the Company's findings at the time of its intervention only and within the limits of Client's instructions, if any. The Company's sole responsibility is to its Client and this document does not exonerate parties to a transaction from exercising all their rights and obligations under the transaction documents. This document cannot be reproduced except in full, without prior written approval of the Company. Any unauthorized alteration, forgery or falsification of the content or appearance of this document is unlawful and offenders may be prosecuted to the fullest extent of the law. Unless otherwise stated the results shown in this test report refer only to the sample(s) tested and such sample(s) are retained for 30 days only.

Attention: To check the authenticity of testing /inspection report & certificate, please contact us at telephone: (86-755) 8307 1443, or email: CN.Doccheck@sgs.com

8.7 Electrical Fast Transients/Burst at Power Port Test Setup



Unless otherwise agreed in writing, this document is issued by the Company subject to its General Conditions of Service printed overleaf, available on request or accessible at <http://www.sgs.com/en/Terms-and-Conditions.aspx> and, for electronic format documents, subject to Terms and Conditions for Electronic Documents at <http://www.sgs.com/en/Terms-and-Conditions/Terms-e-Documents.aspx>. Attention is drawn to the limitation of liability, indemnification and jurisdiction issues defined therein. Any holder of this document is advised that information contained hereon reflects the Company's findings at the time of its intervention only and within the limits of Client's instructions, if any. The Company's sole responsibility is to its Client and this document does not exonerate parties to a transaction from exercising all their rights and obligations under the transaction documents. This document cannot be reproduced except in full, without prior written approval of the Company. Any unauthorized alteration, forgery or falsification of the content or appearance of this document is unlawful and offenders may be prosecuted to the fullest extent of the law. Unless otherwise stated the results shown in this test report refer only to the sample(s) tested and such sample(s) are retained for 30 days only.

Attention: To check the authenticity of testing /inspection report & certificate, please contact us at telephone: (86-755) 8307 1443, or email: CN.Doccheck@sgs.com

8.8 Surge at Power Port Test Setup



Unless otherwise agreed in writing, this document is issued by the Company subject to its General Conditions of Service printed overleaf, available on request or accessible at <http://www.sgs.com/en/Terms-and-Conditions.aspx> and, for electronic format documents, subject to Terms and Conditions for Electronic Documents at <http://www.sgs.com/en/Terms-and-Conditions/Terms-e-Document.aspx>. Attention is drawn to the limitation of liability, indemnification and jurisdiction issues defined therein. Any holder of this document is advised that information contained hereon reflects the Company's findings at the time of its intervention only and within the limits of Client's instructions, if any. The Company's sole responsibility is to its Client and this document does not exonerate parties to a transaction from exercising all their rights and obligations under the transaction documents. This document cannot be reproduced except in full, without prior written approval of the Company. Any unauthorized alteration, forgery or falsification of the content or appearance of this document is unlawful and offenders may be prosecuted to the fullest extent of the law. Unless otherwise stated the results shown in this test report refer only to the sample(s) tested and such sample(s) are retained for 30 days only.

Attention: To check the authenticity of testing /inspection report & certificate, please contact us at telephone: (86-755) 8307 1443, or email: CN.Doccheck@sgs.com

SGS-CSTC Standards Technical Services Co., Ltd. No.198 Kezhu Road, Sciencetech Park, Guangzhou Economic & Technology Development District, Guangzhou, China 510663 t (86-20) 82155555 f (86-20) 82075058 www.sgsgroup.com.cn
 Guangzhou Branch Testing Center IEC Laboratory. 中国·广州·经济技术开发区科学城科珠路198号 邮编: 510663 t (86-20) 82155555 f (86-20) 82075058 sgs.china@sgs.com

8.9 Voltage Dips and Interruptions Test Setup



Unless otherwise agreed in writing, this document is issued by the Company subject to its General Conditions of Service printed overleaf, available on request or accessible at <http://www.sgs.com/en/Terms-and-Conditions.aspx> and, for electronic format documents, subject to Terms and Conditions for Electronic Documents at <http://www.sgs.com/en/Terms-and-Conditions/Terms-e-Documents.aspx>. Attention is drawn to the limitation of liability, indemnification and jurisdiction issues defined therein. Any holder of this document is advised that information contained hereon reflects the Company's findings at the time of its intervention only and within the limits of Client's instructions, if any. The Company's sole responsibility is to its Client and this document does not exonerate parties to a transaction from exercising all their rights and obligations under the transaction documents. This document cannot be reproduced except in full, without prior written approval of the Company. Any unauthorized alteration, forgery or falsification of the content or appearance of this document is unlawful and offenders may be prosecuted to the fullest extent of the law. Unless otherwise stated the results shown in this test report refer only to the sample(s) tested and such sample(s) are retained for 30 days only.

Attention: To check the authenticity of testing /inspection report & certificate, please contact us at telephone: (86-755) 8307 1443, or email: CN.Doccheck@sgs.com

8.10 Conducted Immunity at Power Port (150kHz-230MHz) Test Setup



Unless otherwise agreed in writing, this document is issued by the Company subject to its General Conditions of Service printed overleaf, available on request or accessible at <http://www.sgs.com/en/Terms-and-Conditions.aspx> and, for electronic format documents, subject to Terms and Conditions for Electronic Documents at <http://www.sgs.com/en/Terms-and-Conditions/Terms-e-Documents.aspx>. Attention is drawn to the limitation of liability, indemnification and jurisdiction issues defined therein. Any holder of this document is advised that information contained hereon reflects the Company's findings at the time of its intervention only and within the limits of Client's instructions, if any. The Company's sole responsibility is to its Client and this document does not exonerate parties to a transaction from exercising all their rights and obligations under the transaction documents. This document cannot be reproduced except in full, without prior written approval of the Company. Any unauthorized alteration, forgery or falsification of the content or appearance of this document is unlawful and offenders may be prosecuted to the fullest extent of the law. Unless otherwise stated the results shown in this test report refer only to the sample(s) tested and such sample(s) are retained for 30 days only.

Attention: To check the authenticity of testing /inspection report & certificate, please contact us at telephone: (86-755) 8307 1443, or email: CN.Doccheck@sgs.com

8.11 EUT Constructional Details



Unless otherwise agreed in writing, this document is issued by the Company subject to its General Conditions of Service printed overleaf, available on request or accessible at <http://www.sgs.com/en/Terms-and-Conditions.aspx> and, for electronic format documents, subject to Terms and Conditions for Electronic Documents at <http://www.sgs.com/en/Terms-and-Conditions/Terms-e-Document.aspx>. Attention is drawn to the limitation of liability, indemnification and jurisdiction issues defined therein. Any holder of this document is advised that information contained hereon reflects the Company's findings at the time of its intervention only and within the limits of Client's instructions, if any. The Company's sole responsibility is to its Client and this document does not exonerate parties to a transaction from exercising all their rights and obligations under the transaction documents. This document cannot be reproduced except in full, without prior written approval of the Company. Any unauthorized alteration, forgery or falsification of the content or appearance of this document is unlawful and offenders may be prosecuted to the fullest extent of the law. Unless otherwise stated the results shown in this test report refer only to the sample(s) tested and such sample(s) are retained for 30 days only.

Attention: To check the authenticity of testing /inspection report & certificate, please contact us at telephone: (86-755) 8307 1443, or email: CN.Doccheck@sgs.com



Unless otherwise agreed in writing, this document is issued by the Company subject to its General Conditions of Service printed overleaf, available on request or accessible at <http://www.sgs.com/en/Terms-and-Conditions.aspx> and, for electronic format documents, subject to Terms and Conditions for Electronic Documents at <http://www.sgs.com/en/Terms-and-Conditions/Terms-e-Documents.aspx>. Attention is drawn to the limitation of liability, indemnification and jurisdiction issues defined therein. Any holder of this document is advised that information contained hereon reflects the Company's findings at the time of its intervention only and within the limits of Client's instructions, if any. The Company's sole responsibility is to its Client and this document does not exonerate parties to a transaction from exercising all their rights and obligations under the transaction documents. This document cannot be reproduced except in full, without prior written approval of the Company. Any unauthorized alteration, forgery or falsification of the content or appearance of this document is unlawful and offenders may be prosecuted to the fullest extent of the law. Unless otherwise stated the results shown in this test report refer only to the sample(s) tested and such sample(s) are retained for 30 days only.

Attention: To check the authenticity of testing /inspection report & certificate, please contact us at telephone: (86-755) 8307 1443, or email: CN.Doccheck@sgs.com



Unless otherwise agreed in writing, this document is issued by the Company subject to its General Conditions of Service printed overleaf, available on request or accessible at <http://www.sgs.com/en/Terms-and-Conditions.aspx> and, for electronic format documents, subject to Terms and Conditions for Electronic Documents at <http://www.sgs.com/en/Terms-and-Conditions/Terms-e-Document.aspx>. Attention is drawn to the limitation of liability, indemnification and jurisdiction issues defined therein. Any holder of this document is advised that information contained hereon reflects the Company's findings at the time of its intervention only and within the limits of Client's instructions, if any. The Company's sole responsibility is to its Client and this document does not exonerate parties to a transaction from exercising all their rights and obligations under the transaction documents. This document cannot be reproduced except in full, without prior written approval of the Company. Any unauthorized alteration, forgery or falsification of the content or appearance of this document is unlawful and offenders may be prosecuted to the fullest extent of the law. Unless otherwise stated the results shown in this test report refer only to the sample(s) tested and such sample(s) are retained for 30 days only.

Attention: To check the authenticity of testing /inspection report & certificate, please contact us at telephone: (86-755) 8307 1443, or email: CN.Doccheck@sgs.com

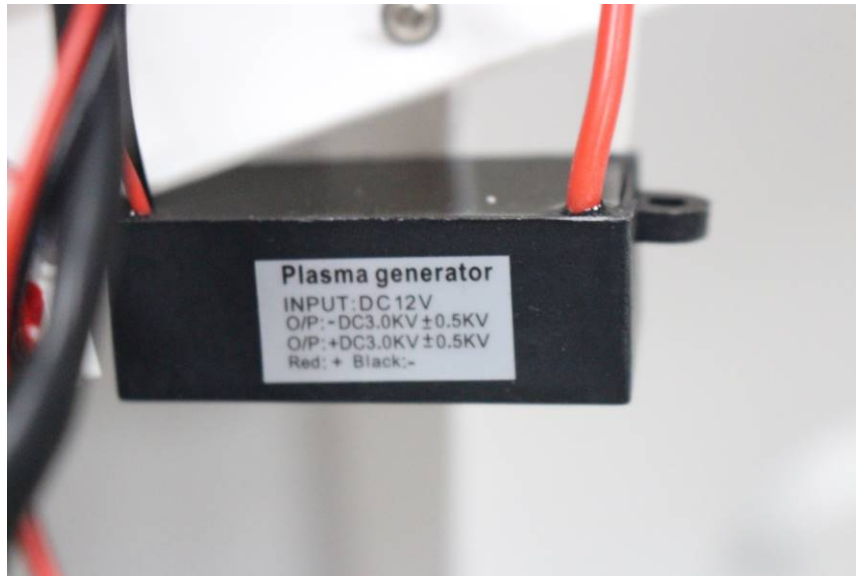

Unless otherwise agreed in writing, this document is issued by the Company subject to its General Conditions of Service printed overleaf, available on request or accessible at <http://www.sgs.com/en/Terms-and-Conditions.aspx> and, for electronic format documents, subject to Terms and Conditions for Electronic Documents at <http://www.sgs.com/en/Terms-and-Conditions/Terms-e-Document.aspx>. Attention is drawn to the limitation of liability, indemnification and jurisdiction issues defined therein. Any holder of this document is advised that information contained hereon reflects the Company's findings at the time of its intervention only and within the limits of Client's instructions, if any. The Company's sole responsibility is to its Client and this document does not exonerate parties to a transaction from exercising all their rights and obligations under the transaction documents. This document cannot be reproduced except in full, without prior written approval of the Company. Any unauthorized alteration, forgery or falsification of the content or appearance of this document is unlawful and offenders may be prosecuted to the fullest extent of the law. Unless otherwise stated the results shown in this test report refer only to the sample(s) tested and such sample(s) are retained for 30 days only.

Attention: To check the authenticity of testing /inspection report & certificate, please contact us at telephone: (86-755) 8307 1443, or email: CN.Doccheck@sgs.com



Unless otherwise agreed in writing, this document is issued by the Company subject to its General Conditions of Service printed overleaf, available on request or accessible at <http://www.sgs.com/en/Terms-and-Conditions.aspx> and, for electronic format documents, subject to Terms and Conditions for Electronic Documents at <http://www.sgs.com/en/Terms-and-Conditions/Terms-e-Documents.aspx>. Attention is drawn to the limitation of liability, indemnification and jurisdiction issues defined therein. Any holder of this document is advised that information contained hereon reflects the Company's findings at the time of its intervention only and within the limits of Client's instructions, if any. The Company's sole responsibility is to its Client and this document does not exonerate parties to a transaction from exercising all their rights and obligations under the transaction documents. This document cannot be reproduced except in full, without prior written approval of the Company. Any unauthorized alteration, forgery or falsification of the content or appearance of this document is unlawful and offenders may be prosecuted to the fullest extent of the law. Unless otherwise stated the results shown in this test report refer only to the sample(s) tested and such sample(s) are retained for 30 days only.

Attention: To check the authenticity of testing /inspection report & certificate, please contact us at telephone: (86-755) 8307 1443, or email: CN.Doccheck@sgs.com



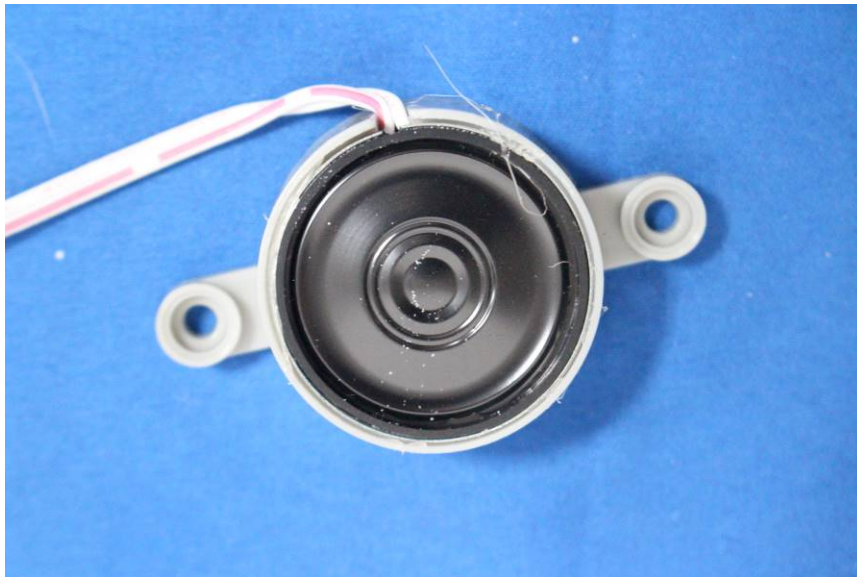

Unless otherwise agreed in writing, this document is issued by the Company subject to its General Conditions of Service printed overleaf, available on request or accessible at <http://www.sgs.com/en/Terms-and-Conditions.aspx> and, for electronic format documents, subject to Terms and Conditions for Electronic Documents at <http://www.sgs.com/en/Terms-and-Conditions/Terms-e-Documents.aspx>. Attention is drawn to the limitation of liability, indemnification and jurisdiction issues defined therein. Any holder of this document is advised that information contained hereon reflects the Company's findings at the time of its intervention only and within the limits of Client's instructions, if any. The Company's sole responsibility is to its Client and this document does not exonerate parties to a transaction from exercising all their rights and obligations under the transaction documents. This document cannot be reproduced except in full, without prior written approval of the Company. Any unauthorized alteration, forgery or falsification of the content or appearance of this document is unlawful and offenders may be prosecuted to the fullest extent of the law. Unless otherwise stated the results shown in this test report refer only to the sample(s) tested and such sample(s) are retained for 30 days only.

Attention: To check the authenticity of testing /inspection report & certificate, please contact us at telephone: (86-755) 8307 1443, or email: CN.Doccheck@sgs.com



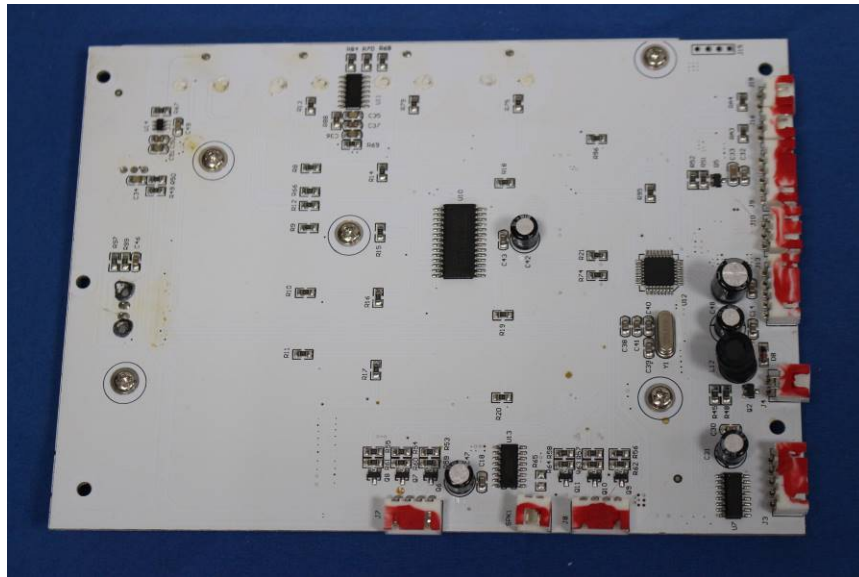
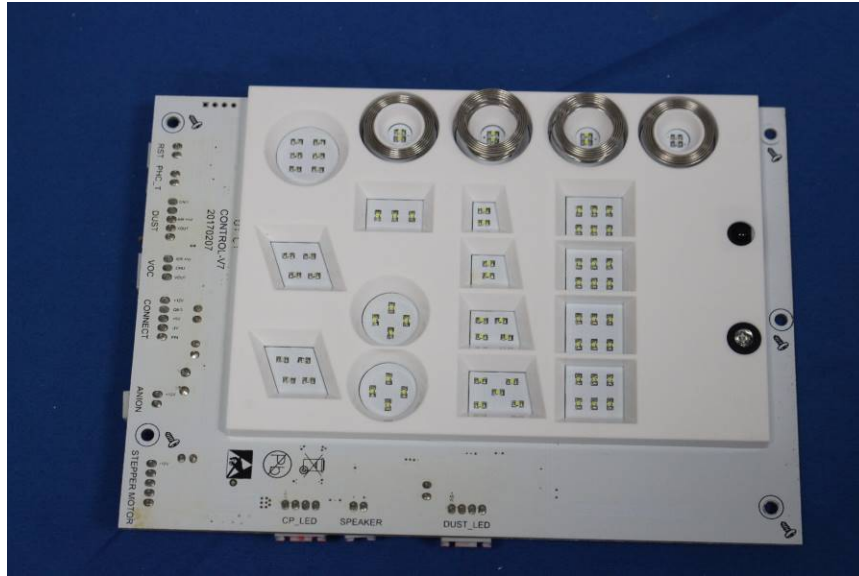

Unless otherwise agreed in writing, this document is issued by the Company subject to its General Conditions of Service printed overleaf, available on request or accessible at <http://www.sgs.com/en/Terms-and-Conditions.aspx> and, for electronic format documents, subject to Terms and Conditions for Electronic Documents at <http://www.sgs.com/en/Terms-and-Conditions/Terms-e-Document.aspx>. Attention is drawn to the limitation of liability, indemnification and jurisdiction issues defined therein. Any holder of this document is advised that information contained hereon reflects the Company's findings at the time of its intervention only and within the limits of Client's instructions, if any. The Company's sole responsibility is to its Client and this document does not exonerate parties to a transaction from exercising all their rights and obligations under the transaction documents. This document cannot be reproduced except in full, without prior written approval of the Company. Any unauthorized alteration, forgery or falsification of the content or appearance of this document is unlawful and offenders may be prosecuted to the fullest extent of the law. Unless otherwise stated the results shown in this test report refer only to the sample(s) tested and such sample(s) are retained for 30 days only.

Attention: To check the authenticity of testing /inspection report & certificate, please contact us at telephone: (86-755) 8307 1443, or email: CN.Doccheck@sgs.com

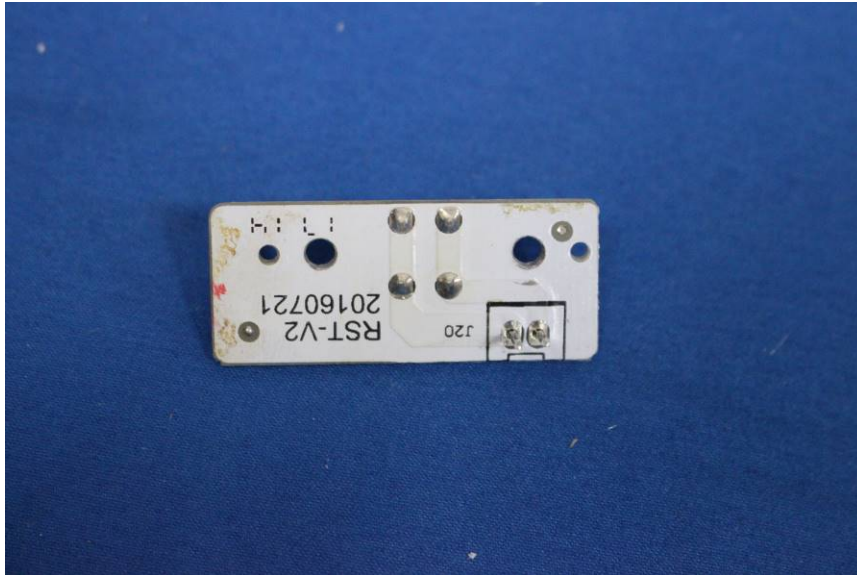

Unless otherwise agreed in writing, this document is issued by the Company subject to its General Conditions of Service printed overleaf, available on request or accessible at <http://www.sgs.com/en/Terms-and-Conditions.aspx> and, for electronic format documents, subject to Terms and Conditions for Electronic Documents at <http://www.sgs.com/en/Terms-and-Conditions/Terms-e-Document.aspx>. Attention is drawn to the limitation of liability, indemnification and jurisdiction issues defined therein. Any holder of this document is advised that information contained hereon reflects the Company's findings at the time of its intervention only and within the limits of Client's instructions, if any. The Company's sole responsibility is to its Client and this document does not exonerate parties to a transaction from exercising all their rights and obligations under the transaction documents. This document cannot be reproduced except in full, without prior written approval of the Company. Any unauthorized alteration, forgery or falsification of the content or appearance of this document is unlawful and offenders may be prosecuted to the fullest extent of the law. Unless otherwise stated the results shown in this test report refer only to the sample(s) tested and such sample(s) are retained for 30 days only.

Attention: To check the authenticity of testing /inspection report & certificate, please contact us at telephone: (86-755) 8307 1443, or email: CN.Doccheck@sgs.com

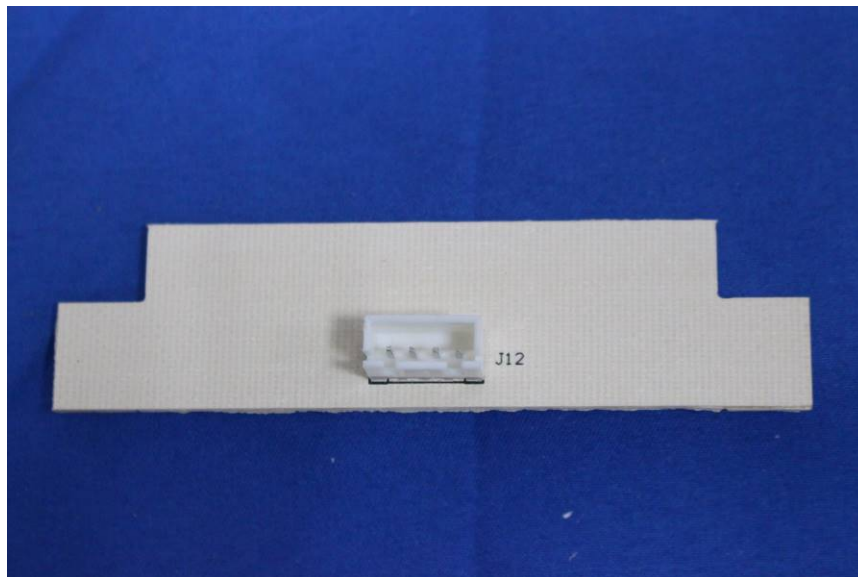
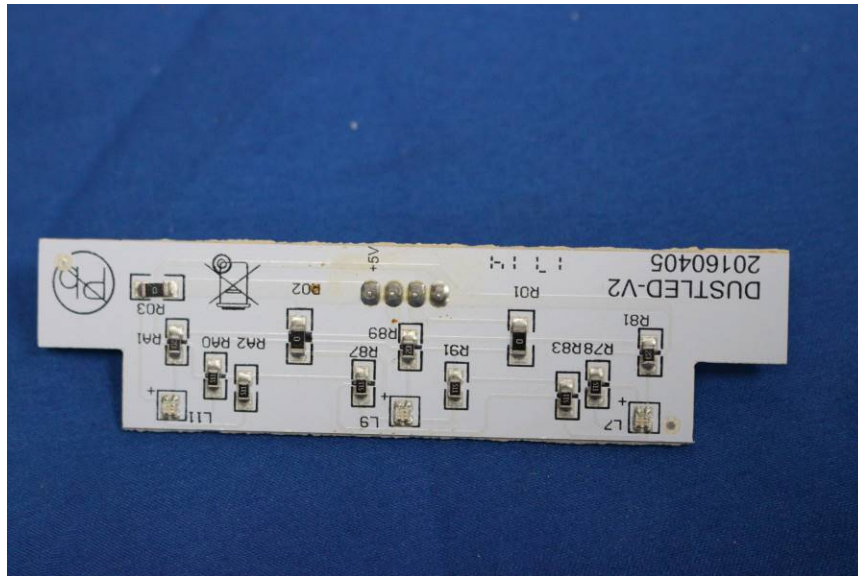

Unless otherwise agreed in writing, this document is issued by the Company subject to its General Conditions of Service printed overleaf, available on request or accessible at <http://www.sgs.com/en/Terms-and-Conditions.aspx> and, for electronic format documents, subject to Terms and Conditions for Electronic Documents at <http://www.sgs.com/en/Terms-and-Conditions/Terms-e-Document.aspx>. Attention is drawn to the limitation of liability, indemnification and jurisdiction issues defined therein. Any holder of this document is advised that information contained hereon reflects the Company's findings at the time of its intervention only and within the limits of Client's instructions, if any. The Company's sole responsibility is to its Client and this document does not exonerate parties to a transaction from exercising all their rights and obligations under the transaction documents. This document cannot be reproduced except in full, without prior written approval of the Company. Any unauthorized alteration, forgery or falsification of the content or appearance of this document is unlawful and offenders may be prosecuted to the fullest extent of the law. Unless otherwise stated the results shown in this test report refer only to the sample(s) tested and such sample(s) are retained for 30 days only.

Attention: To check the authenticity of testing /inspection report & certificate, please contact us at telephone: (86-755) 8307 1443, or email: CN.Doccheck@sgs.com

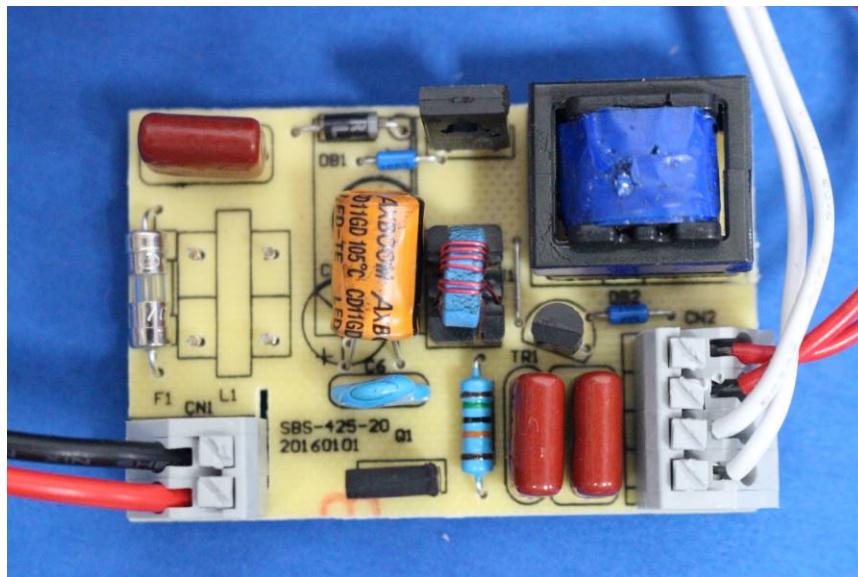
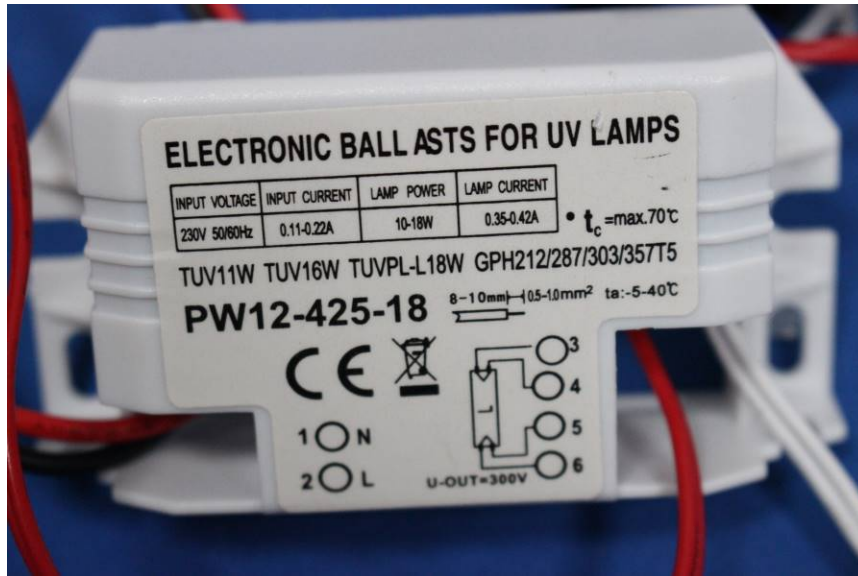

Unless otherwise agreed in writing, this document is issued by the Company subject to its General Conditions of Service printed overleaf, available on request or accessible at <http://www.sgs.com/en/Terms-and-Conditions.aspx> and, for electronic format documents, subject to Terms and Conditions for Electronic Documents at <http://www.sgs.com/en/Terms-and-Conditions/Terms-e-Documents.aspx>. Attention is drawn to the limitation of liability, indemnification and jurisdiction issues defined therein. Any holder of this document is advised that information contained hereon reflects the Company's findings at the time of its intervention only and within the limits of Client's instructions, if any. The Company's sole responsibility is to its Client and this document does not exonerate parties to a transaction from exercising all their rights and obligations under the transaction documents. This document cannot be reproduced except in full, without prior written approval of the Company. Any unauthorized alteration, forgery or falsification of the content or appearance of this document is unlawful and offenders may be prosecuted to the fullest extent of the law. Unless otherwise stated the results shown in this test report refer only to the sample(s) tested and such sample(s) are retained for 30 days only.

Attention: To check the authenticity of testing / inspection report & certificate, please contact us at telephone: (86-755) 8307 1443, or email: CN.Doccheck@sgs.com
 No.198 Kezhu Road, Sciencetech Park, Guangzhou Economic & Technology Development District, Guangzhou, China 510663 t (86-20) 82155555 f (86-20) 82075058 www.sgs.com
 中国·广州·经济技术开发区科学城科珠路198号 邮编: 510663 t (86-20) 82155555 f (86-20) 82075058 sgs.china@sgs.com

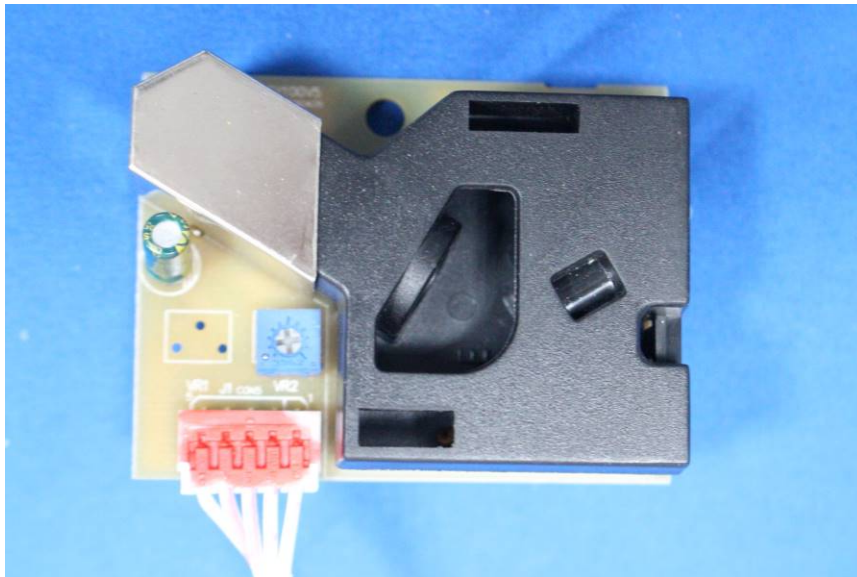
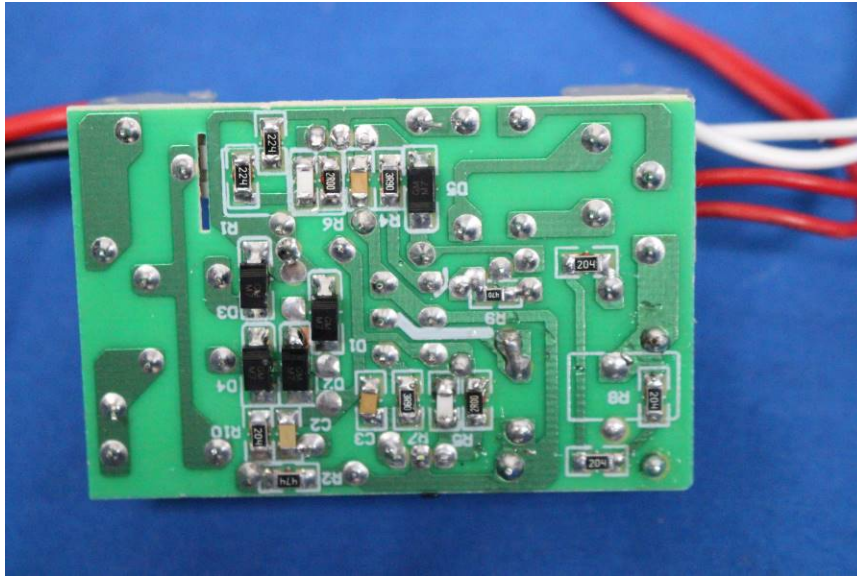

Unless otherwise agreed in writing, this document is issued by the Company subject to its General Conditions of Service printed overleaf, available on request or accessible at <http://www.sgs.com/en/Terms-and-Conditions.aspx> and, for electronic format documents, subject to Terms and Conditions for Electronic Documents at <http://www.sgs.com/en/Terms-and-Conditions/Terms-e-Document.aspx>. Attention is drawn to the limitation of liability, indemnification and jurisdiction issues defined therein. Any holder of this document is advised that information contained hereon reflects the Company's findings at the time of its intervention only and within the limits of Client's instructions, if any. The Company's sole responsibility is to its Client and this document does not exonerate parties to a transaction from exercising all their rights and obligations under the transaction documents. This document cannot be reproduced except in full, without prior written approval of the Company. Any unauthorized alteration, forgery or falsification of the content or appearance of this document is unlawful and offenders may be prosecuted to the fullest extent of the law. Unless otherwise stated the results shown in this test report refer only to the sample(s) tested and such sample(s) are retained for 30 days only.

Attention: To check the authenticity of testing /inspection report & certificate, please contact us at telephone: (86-755) 8307 1443, or email: CN.Doccheck@sgs.com



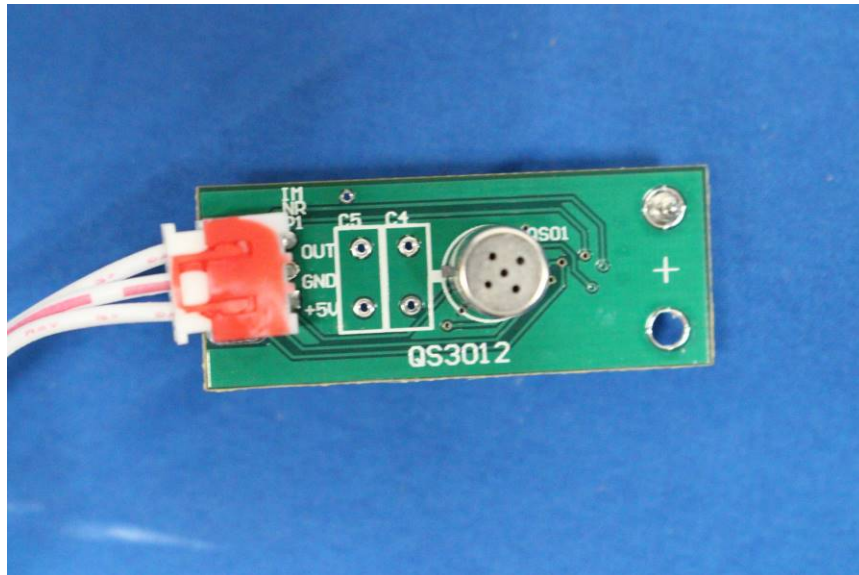
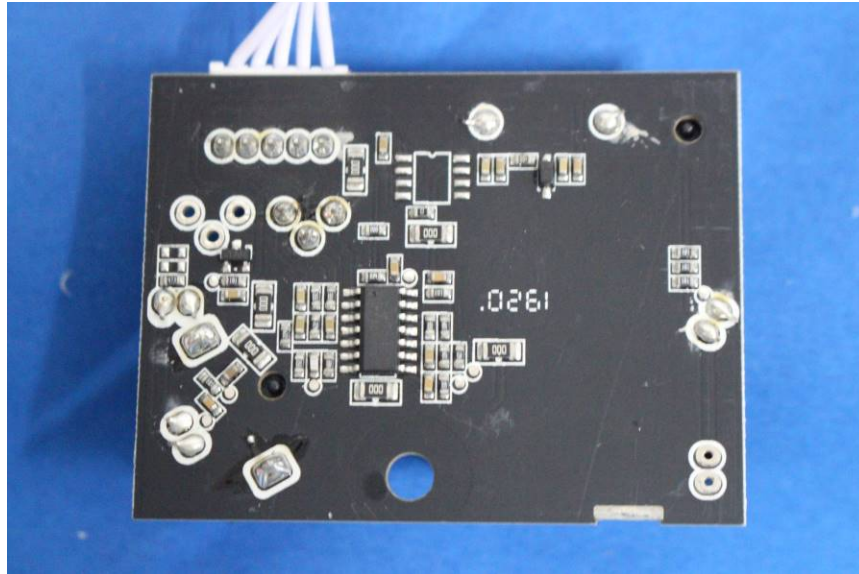

Unless otherwise agreed in writing, this document is issued by the Company subject to its General Conditions of Service printed overleaf, available on request or accessible at <http://www.sgs.com/en/Terms-and-Conditions.aspx> and, for electronic format documents, subject to Terms and Conditions for Electronic Documents at <http://www.sgs.com/en/Terms-and-Conditions/Terms-e-Document.aspx>. Attention is drawn to the limitation of liability, indemnification and jurisdiction issues defined therein. Any holder of this document is advised that information contained hereon reflects the Company's findings at the time of its intervention only and within the limits of Client's instructions, if any. The Company's sole responsibility is to its Client and this document does not exonerate parties to a transaction from exercising all their rights and obligations under the transaction documents. This document cannot be reproduced except in full, without prior written approval of the Company. Any unauthorized alteration, forgery or falsification of the content or appearance of this document is unlawful and offenders may be prosecuted to the fullest extent of the law. Unless otherwise stated the results shown in this test report refer only to the sample(s) tested and such sample(s) are retained for 30 days only.

Attention: To check the authenticity of testing /inspection report & certificate, please contact us at telephone: (86-755) 8307 1443, or email: CN.Doccheck@sgs.com

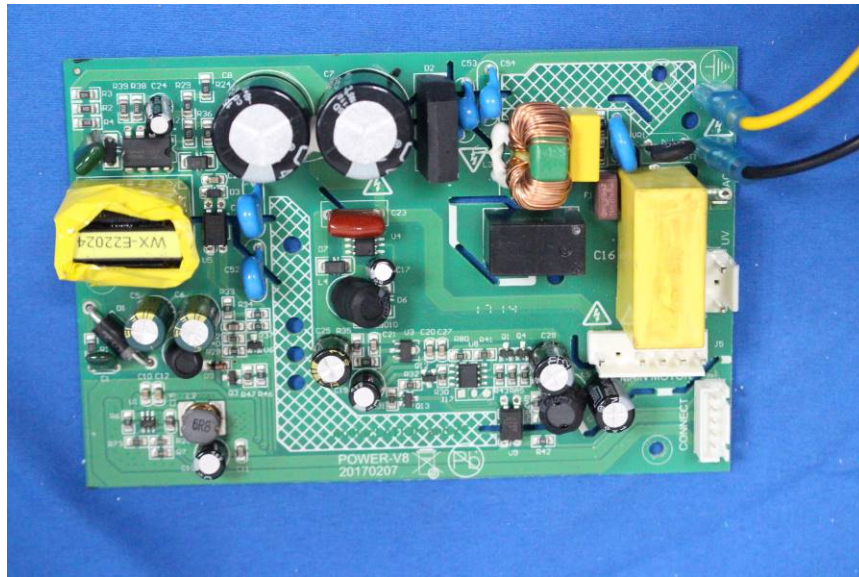
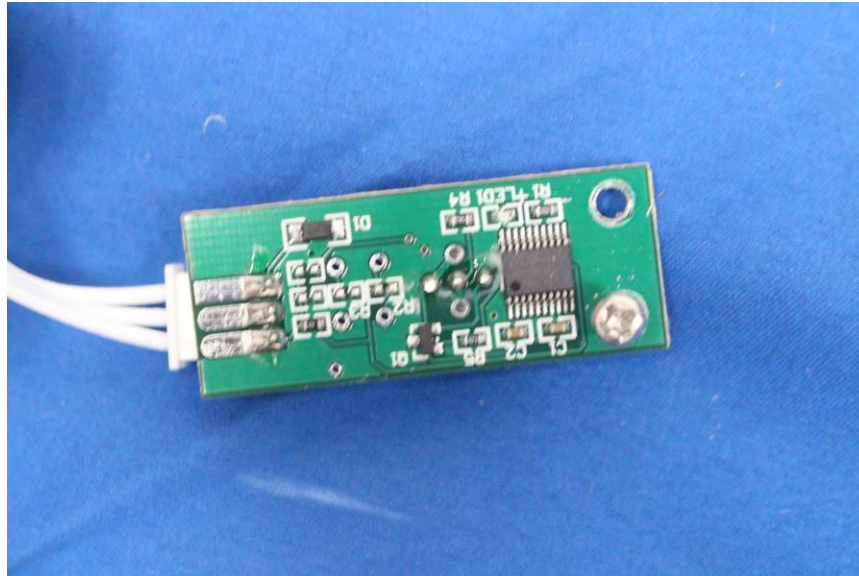

Unless otherwise agreed in writing, this document is issued by the Company subject to its General Conditions of Service printed overleaf, available on request or accessible at <http://www.sgs.com/en/Terms-and-Conditions.aspx> and, for electronic format documents, subject to Terms and Conditions for Electronic Documents at <http://www.sgs.com/en/Terms-and-Conditions/Terms-e-Document.aspx>. Attention is drawn to the limitation of liability, indemnification and jurisdiction issues defined therein. Any holder of this document is advised that information contained hereon reflects the Company's findings at the time of its intervention only and within the limits of Client's instructions, if any. The Company's sole responsibility is to its Client and this document does not exonerate parties to a transaction from exercising all their rights and obligations under the transaction documents. This document cannot be reproduced except in full, without prior written approval of the Company. Any unauthorized alteration, forgery or falsification of the content or appearance of this document is unlawful and offenders may be prosecuted to the fullest extent of the law. Unless otherwise stated the results shown in this test report refer only to the sample(s) tested and such sample(s) are retained for 30 days only.

Attention: To check the authenticity of testing /inspection report & certificate, please contact us at telephone: (86-755) 8307 1443, or email: CN.Doccheck@sgs.com

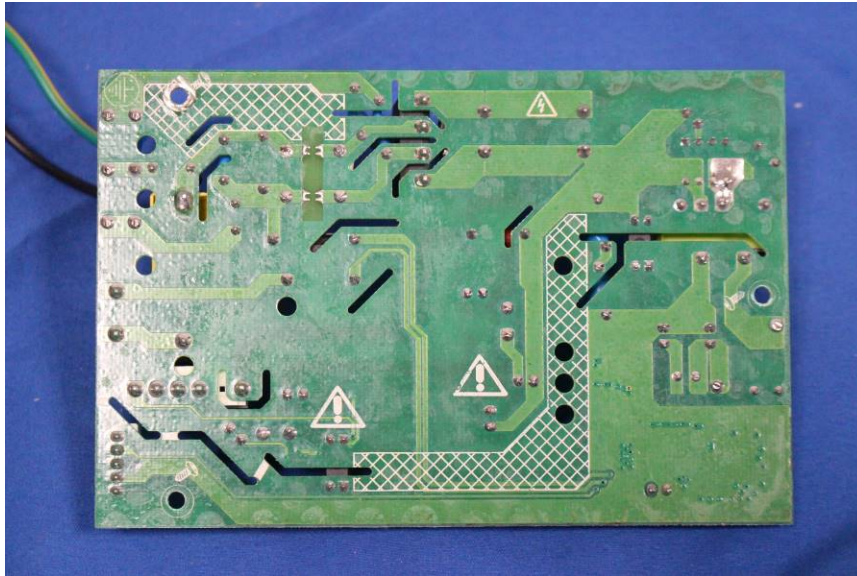

Unless otherwise agreed in writing, this document is issued by the Company subject to its General Conditions of Service printed overleaf, available on request or accessible at <http://www.sgs.com/en/Terms-and-Conditions.aspx> and, for electronic format documents, subject to Terms and Conditions for Electronic Documents at <http://www.sgs.com/en/Terms-and-Conditions/Terms-e-Document.aspx>. Attention is drawn to the limitation of liability, indemnification and jurisdiction issues defined therein. Any holder of this document is advised that information contained hereon reflects the Company's findings at the time of its intervention only and within the limits of Client's instructions, if any. The Company's sole responsibility is to its Client and this document does not exonerate parties to a transaction from exercising all their rights and obligations under the transaction documents. This document cannot be reproduced except in full, without prior written approval of the Company. Any unauthorized alteration, forgery or falsification of the content or appearance of this document is unlawful and offenders may be prosecuted to the fullest extent of the law. Unless otherwise stated the results shown in this test report refer only to the sample(s) tested and such sample(s) are retained for 30 days only.

Attention: To check the authenticity of testing /inspection report & certificate, please contact us at telephone: (86-755) 8307 1443, or email: CN.Doccheck@sgs.com

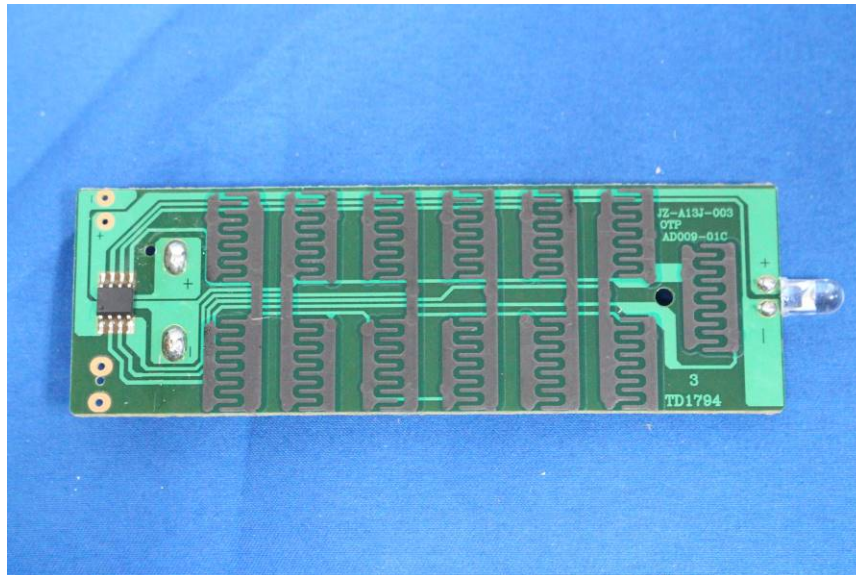

Unless otherwise agreed in writing, this document is issued by the Company subject to its General Conditions of Service printed overleaf, available on request or accessible at <http://www.sgs.com/en/Terms-and-Conditions.aspx> and, for electronic format documents, subject to Terms and Conditions for Electronic Documents at <http://www.sgs.com/en/Terms-and-Conditions/Terms-e-Document.aspx>. Attention is drawn to the limitation of liability, indemnification and jurisdiction issues defined therein. Any holder of this document is advised that information contained hereon reflects the Company's findings at the time of its intervention only and within the limits of Client's instructions, if any. The Company's sole responsibility is to its Client and this document does not exonerate parties to a transaction from exercising all their rights and obligations under the transaction documents. This document cannot be reproduced except in full, without prior written approval of the Company. Any unauthorized alteration, forgery or falsification of the content or appearance of this document is unlawful and offenders may be prosecuted to the fullest extent of the law. Unless otherwise stated the results shown in this test report refer only to the sample(s) tested and such sample(s) are retained for 30 days only.

Attention: To check the authenticity of testing /inspection report & certificate, please contact us at telephone: (86-755) 8307 1443, or email: CN.Doccheck@sgs.com

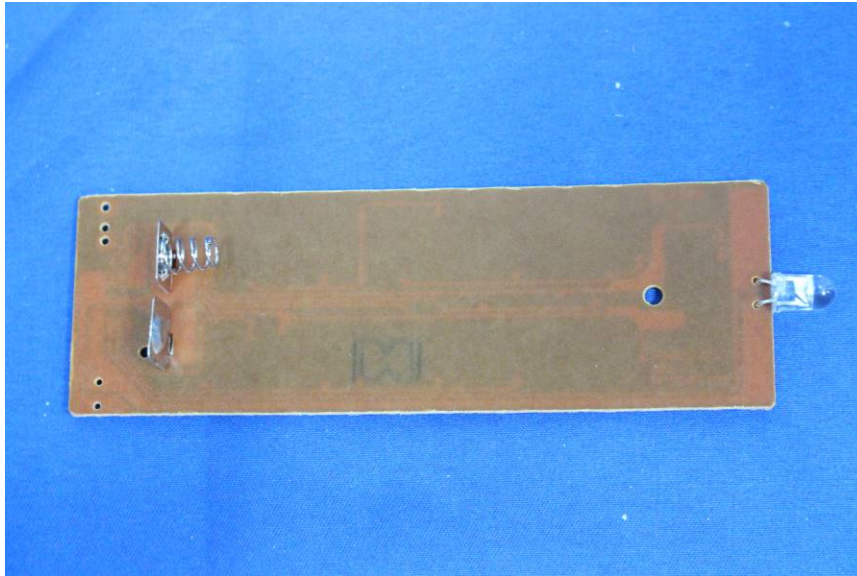

--End of Report--



Unless otherwise agreed in writing, this document is issued by the Company subject to its General Conditions of Service printed overleaf, available on request or accessible at <http://www.sgs.com/en/Terms-and-Conditions.aspx> and, for electronic format documents, subject to Terms and Conditions for Electronic Documents at <http://www.sgs.com/en/Terms-and-Conditions/Terms-e-Documents.aspx>. Attention is drawn to the limitation of liability, indemnification and jurisdiction issues defined therein. Any holder of this document is advised that information contained hereon reflects the Company's findings at the time of its intervention only and within the limits of Client's instructions, if any. The Company's sole responsibility is to its Client and this document does not exonerate parties to a transaction from exercising all their rights and obligations under the transaction documents. This document cannot be reproduced except in full, without prior written approval of the Company. Any unauthorized alteration, forgery or falsification of the content or appearance of this document is unlawful and offenders may be prosecuted to the fullest extent of the law. Unless otherwise stated the results shown in this test report refer only to the sample(s) tested and such sample(s) are retained for 30 days only.

Attention: To check the authenticity of testing /inspection report & certificate, please contact us at telephone: (86-755) 8307 1443, or email: CN.Doccheck@sgs.com